

S T R E E T F U R N I T U R E C R E A T O R

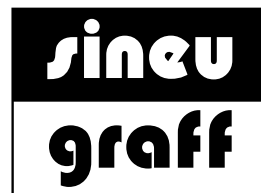

by



STREET FURNITURE

## INVENTED AND PRODUCED IN FRANCE

---

Sineu Graff is engaged in a trajectory to reduce its carbon footprint, according to the **ACT Step by Step approach labelled by ADÈME**. After an initial drop of 8% in its emissions between 2011 and 2019, according to carbon balance reports that have been drawn up, Sineu Graff has defined an ambitious action plan, aimed at achieving the objectives set in the PARIS agreements for 2030.

Sineu Graff also attaches great importance to the durability and longevity of its products. Its street furniture is designed to resist weather conditions, wear and acts of vandalism, which helps reduce the need for frequent replacement and maintenance, and **avoids wasting resources**. In addition, the company takes a circular economy approach **by promoting the repair, reconditioning, reuse and recycling of its end-of-life products**.

Sineu Graff has been promoting short circuits for several years, as evidenced by the **“Local Partnership” Trophy** awarded by Idée Alsace (now ID Alsace) in 2012.

Sineu Graff strives to create, in collaboration with numerous designers, aesthetic, functional, eco-designed street furniture, thus contributing to the sustainable development of urban spaces. Thanks to these initiatives, Sineu Graff obtained **Janus de la Cité 2023, awarded by the French Design Institute**, for the lasting collaboration between a street furniture producer and designer Cécile Planchais, **for the new Tango range**.

See page 238 to find out more!

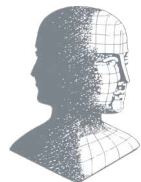

JANUS 2023  
DE LA CITÉ



The city, the hub of our personal, social and professional lives, remains the predominant model today in the early 21<sup>st</sup> century. Urban landscaping, with its configuration of volumes and empty spaces, creates convergence zones where the most divergent aspirations of the city mingle: public spaces.

We want them to be both quiet and busy, lively and cosy. However, our requirements remain unchanged: to experience pleasure when in the city, whether on foot, behind the wheel or riding a bicycle. The city belongs to us, which is why we all share the same feeling that public spaces and their furniture are designed for us, forming an integral part of our living environment.

Much more than just decoration, street furniture is perceived as an obvious choice, a necessary part of a fulfilling city lifestyle, a true service provided to its inhabitants. We do not expect that street furniture will provide the same service in a landscaped park as on a pedestrian route.

However, we always want to be able to find a seat, a litter bin nearby, especially since the emergence of soft modes of transport, synonymous with journeys made on foot, thus requiring a greater number of pleasant places for seating furniture.

How can we create these urban spaces, open to all, without furniture for rest, to keep the place clean, for leisure or safety, promising relaxation, health, Confort and protection? But also endowed with a unique aesthetic, in harmony with its times and its environment, whose style it determines almost exclusively.

To do this, a rich, broad range of designs and planning solutions is needed to satisfy the most varied tastes of the general public and adapt to each use and landscaping context. Relaxation furniture combining design and Confort that's ideal for social interaction, discreet but omnipresent availability of furniture that's all about cleanliness, controlled vegetation for street planting furniture, a feeling of security and calm for protective furniture, as well as open-access sports development solutions.

That's why our triple ambition is to make public space more attractive, create a soothing atmosphere and promote social ties. Our understanding of cities' goals for urban landscaping means we can consistently deliver real innovation. It's not just a matter of new products, but useful products that innovate and make life easier in the city,

products with integrated services. Ensuring the well-being of users of urban spaces by promoting sharing, Confort and pleasure is a fundamental commitment for us.

Our real ambition is to help increase the attractiveness of cities, sensitive to our know-how and culture of public tastes and concerns.

The secret of our expertise and our understanding of changing expectations, needs and uses related to furniture for relaxation, cleanliness, safety or leisure, lies in the relationships and interactions we have maintained for more than 50 years with our Customizeders, landscape architects, decision makers and specialist designers who help us validate the best solutions chosen by users. It's thanks to this proven experience that we can claim to be "public".

For us, it's essential to have an ambitious vision so that communities and their people can benefit from it.

**Vincent Schaller**  
**CEO, Sineu Graff**



Alsoce

# Contents

## Sustainable city - Page 8



**Reliefs litter bin**  
Page 10



**Refuge bench®**  
Page 12



**Greffon**  
Page 14



**Mote composting island**  
Page 16

## Clean city - Page 20



**Easy Grip® patent**  
Page 22



**Sorting shelters**  
Page 24



**Selective sorting bins**  
Page 26



**Contemporary with flat lids**  
Page 30



**Contemporary with sloping lid**  
Page 32



**Easy**  
Page 36



**Tulipe**  
Page 38



**Eidos**  
Page 40



**Wood litter bins**  
Page 42



**Oblong litter bins**  
Page 43



**City litter bins**  
Page 46



**Bag holders**  
Page 47



**Ashtrays**  
Page 48



**Jumbo® - Underground tank**  
Page 52



**i-apps platform®**  
Page 54

# Contents

**Intimate city** - Page 56

*Original collections*



**Nine**  
Page 58

*Original collections*



**Wooden Arobase**  
Page 62

*Original collections*



**Steel Arobase**  
Page 67

*Large spaces*



**Grand Large**  
Page 68



**Link**  
Page 72



**Bobine**  
Page 80



**Affinité**  
Page 82



**Idylle**  
Page 86



**Pétales**  
Page 92



**Tango City**  
Page 94



**Tango Wood**  
Page 96



**Garden City**  
Page 98



**Twist**  
Page 100



**Twist city**  
Page 102



**Azur**  
Page 106



**Conversation**  
Page 108



**Confort**  
Page 110



**Confort - RRP**  
Page 112



**Confort City**  
Page 113



**Confort Evolution**  
Page 114



**Confort Evolution City**  
Page 115



**Confort Evolution RRP**  
Page 116



**Centaure - Royal Expression**  
Page 117



**Centaure - Royal Expression - RRP**  
Page 118



**Optima**  
Page 122



**Opticar**  
Page 1123



**Optima City**  
Page 124



**Optima laser cut**  
Page 125

# Contents

## Intimate city - Page 56



**Zénith**  
Page 126



**Zénith City**  
Page 127



**Rendez-vous**  
Page 128



**Rendez-vous City**  
Page 129



**Métropolis**  
Page 130



**Opéra**  
Page 131



**Victoria**  
Page 132

*Original collections*



**Aliou**  
Page 136

*Original collections*



**Rubber Line**  
Page 138

*Original collections*



**Live**  
Page 142

## Green city - Page 148

**sineu flor**



**Sineu Flor® patent**  
Page 150



**Steel Garden**  
Page 152



**Mobile Gardens**  
Page 154

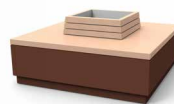

**Mobile planters**  
Page 155



**Ylozen**  
Page 156



**Volubilis**  
Page 160



**Urban vases**  
Page 162



**Steel planters**  
Page 166



**Wooden planters**  
Page 168



**Steel tree grilles**  
Page 172



**Cast iron tree grilles**  
Page 174



**Tree guards**  
Page 176

# Contents

## Safe city - Page 180



**Bicycle Guards**  
Page 182



**Scooter support**  
Page 184



**Bollards and Posts**  
Page 188



**Barriers**  
Page 192



**Totems**  
Page 196



**Anti-intrusion**  
Page 198

## Lively city - Page 200



**Mouv'roc®**  
Page 202



**Open Mouv'roc®**  
Page 204



**Combo satellites**  
Page 212



**Solo satellites**  
Page 214



**Space'Roc®**  
Page 218

## Ingenious city - Page 220

*Private collections*



**Large spaces**  
Page 221



**Tailor-made creations**  
Page 228

*Private collections*



**The Freedom Bench**  
Page 234

*Private collections*



**Logs seat**  
Page 236

*Private collections*



**Podium**  
Page 238



**About Sineu Graff**  
Page 240



**Website Configurator**  
Page 244

# Sustainable city

## A sustainable future, one step at a time.

Sustainable development calls to mind a bright vision of a harmonious future between humanity and its environment. It's an approach that's part of a story of balance, where the judicious use of natural resources and preservation of biodiversity are at the heart of our actions. The optimisation of materials, the creative reuse and harmonisation of urban spaces reflect our commitment to a sustainable way of life. The necessary cooling of cities and restoration of soil permeability, particularly in schoolyards, add to this approach. By integrating more vegetation and permeable areas into our urban environments, we promote thermal regulation, reduce heat islands and improve citizens' quality of life. Composting in an urban environment, inspired by the natural cycle of plants, also demonstrates our desire to create communities that are more connected to nature and respectful of its rhythm. As such, the city is transformed into a laboratory of ideals where sustainability and preservation find a vibrant echo.





Refuge bench®



**Reliefs**  
Ref. 20 0310

# Reliefs

**Design:** Philippe RIEHLING

**Materials**

Zinc and powder coated steel  
Unstained hardwood or larch



Lock



Ashtray



Cigarette snuffer



Dog bag dispenser



Visibility strip



**Reliefs**

Ref. 20 0310  
Inner bin 70 L  
Or bag holder 95 L

**Double stream reliefs**

Ref. 20 0320  
Inner bins 2 x 70 L  
Or bag holder 2 x 100 L

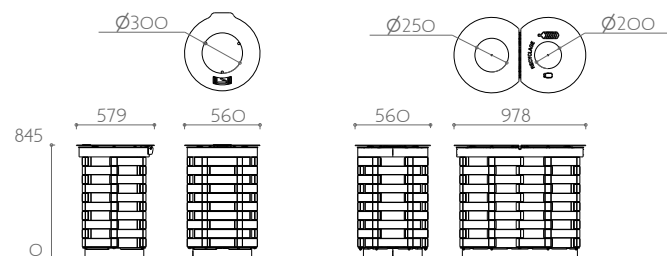

**The eco-designed Reliefs litter bin was created by eco-designer Philippe Riehling, with the aim of encouraging the reuse of our materials.**

Designed from the recovery of unstained wood scraps (larch or hardwood) previously used for the manufacture of seating furniture, the body of this bin is made of a random mix of these 2 wood species. Wood, even cut, continues to store CO<sub>2</sub>. So this bin is a real asset for cooling cities!

# Refuge bench®

**Design:** Julien HOFFMANN & Philippe RIEHLING  
Défi Ecologique

**Materials:**

Structure and facings: Zinc and powder coated steel  
Seating: robinia

## Providing a participatory educational tool

A QR code placed on the Refuge bench® gives access to the site, explaining the device and its objectives, giving information on the insects that live there and their role in biodiversity. Internet users can join in by sharing their observations, which will provide a valuable mine of information and data to share.



**Straight design Rear view**  
Ref. 10 4031 AM10 OP00

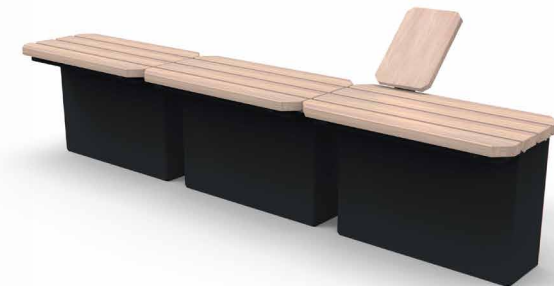

**Straight design Front view**



**L-shaped design Rear view**  
Ref. 10 4032 AM10 OP00

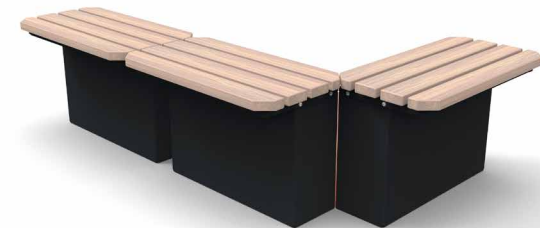

**L-shaped design Front view**

## An urban seat to support biodiversity



### Encouraging nature back into the city

The Refuge bench® is meant to have a direct, local, visible impact on biodiversity. Different species of insect, such as Chrysopidae, ladybirds and Anthocoriadae can settle, flourish and reproduce in the substrates placed in the compartments, providing a source of food for the little insectivorous birds that have found their home in the nearby surroundings.

# Refuge bench®

**Design:** Julien HOFFMANN & Philippe RIEHLING  
Défi Ecologique

**Materials:**

Structure and facings: Zinc and powder coated steel  
Seating: robinia



U-shaped design Front view

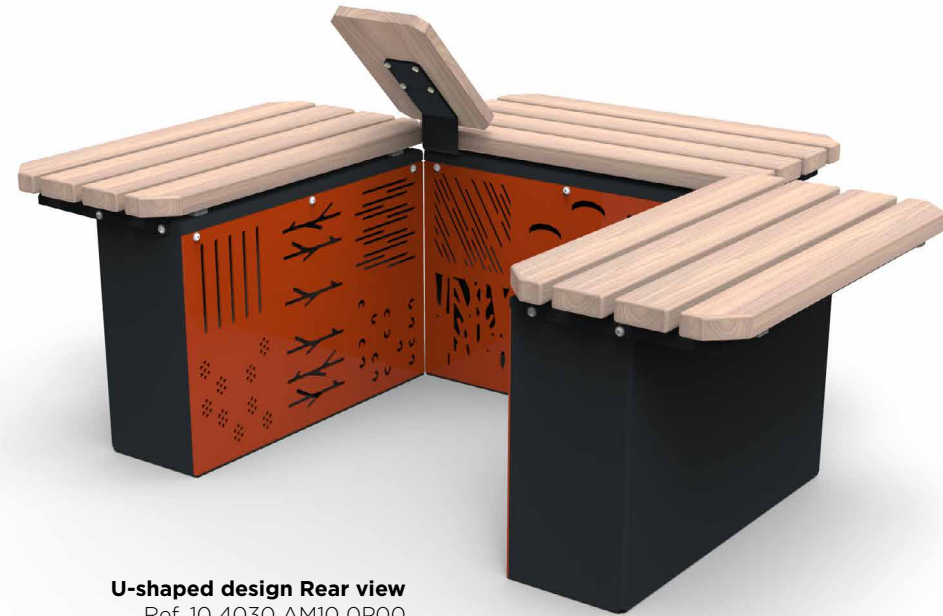

U-shaped design Rear view

Ref. 10 4030 AM10 OP00

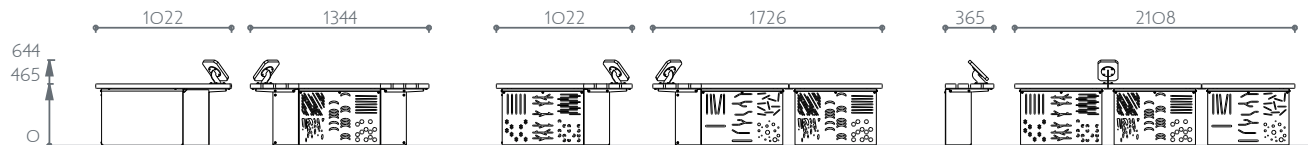



Greffon

**Greffon: the concept of reuse**

Use existing furniture in your public space, add a backrest for Confort or low seating for relaxation, and create furniture with new postures.

# Greffon

**Design:** Gwendoline DOS SANTOS

**Materials:**

Seats and low tabletops:  
raw wood or recycled reinforced plastic.  
Legs and structure of the seats and tables:  
Zinc and powder coated steel



**High seating**  
Ref. 10 2510

**Low seating**  
Ref. 10 2515

**Stool or low table**

Ref. 10 2540

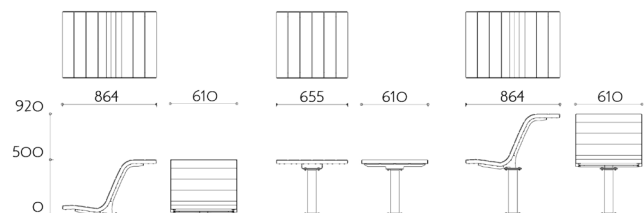

# Mote

**Design:** Aliénor MORVAN

**Materials:**

Galvanised steel bins

Lids in zinc and powder coated steel

Grating: Structure in galvanised steel and unstained larch wood

Information panels in HPL



## Mote island: Widening access to shared composting in urban environments

The composting island consists of different bins, each of which has a specific function.

They are differentiated by height and a colour code to make them easy to identify.

The island embodies the plant lifecycle from growth to decomposition.

Different configurations are possible to help them adapt to the location, community and budget.

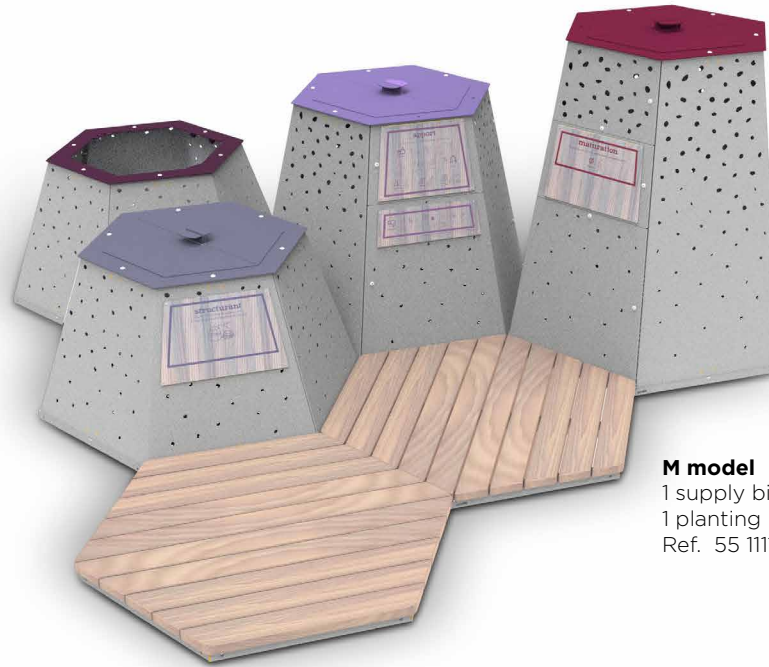

**M model**

1 supply bin | 1 structuring bin | 1 maturation bin |

1 planting bin | 2 wooden duckboards

Ref. 55 1111-2 ZM20 0000



**S model**

Ref. 55 1110-1 ZM20 0000

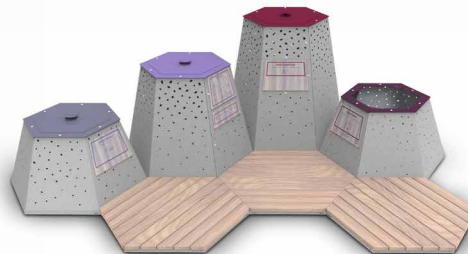

**L model**

Ref. 55 1111-3 ZM20 0000

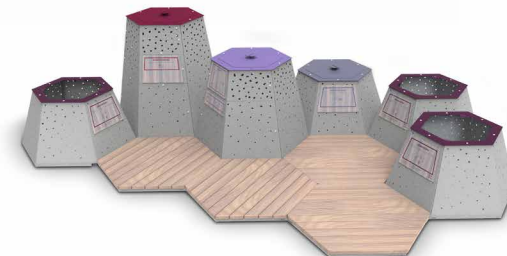

**XL model**

Ref. 55 1113-4 ZM20 0000

## Shared composting in urban environments

# Mote

**Design:** Aliénor MORVAN

**Materials:**

Galvanised steel bins  
Lids in zinc and powder coated steel  
Grating: Structure in galvanised steel and unstained larch wood  
Information panels in HPL

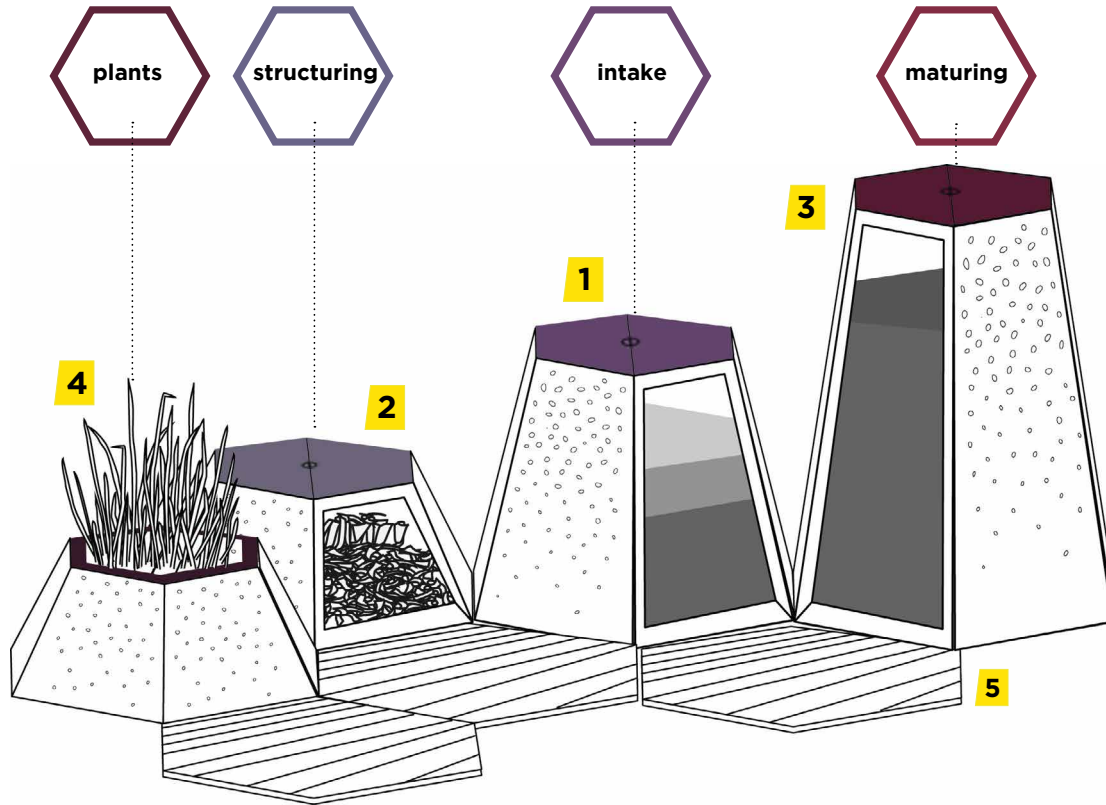

### Composition of the island:

- 1 An intake bin:** Users deposit their organic matter here.
- 2 A structuring bin:** storage of brown materials essential to the nitrogen/carbon balance (dead leaves, ground material, etc.). 1/3 bucket with each intake.
- 3 A maturing bin:** when the supply bin is full, the compost is transferred to a larger bin where it turns into fertiliser after a year.
- 4 Planting bins:** they embody the purpose of composting. The island therefore embodies the entire plant lifecycle from decomposition to growth and so on.
- 5 Wooden duckboards :** Providing dry access to the island.

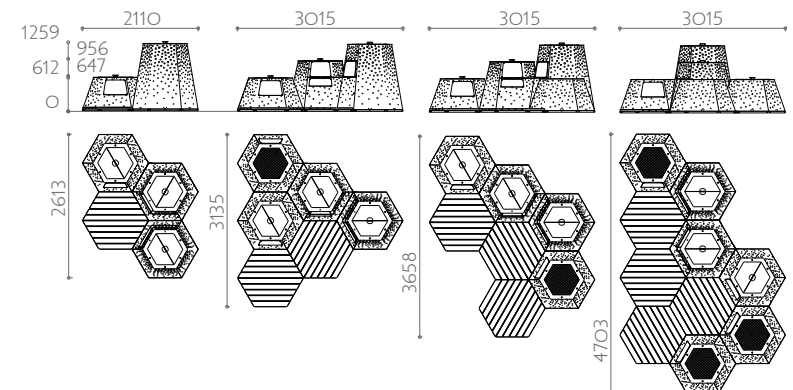



**Refuge bench®**  
Saint Etienne - 42 - France

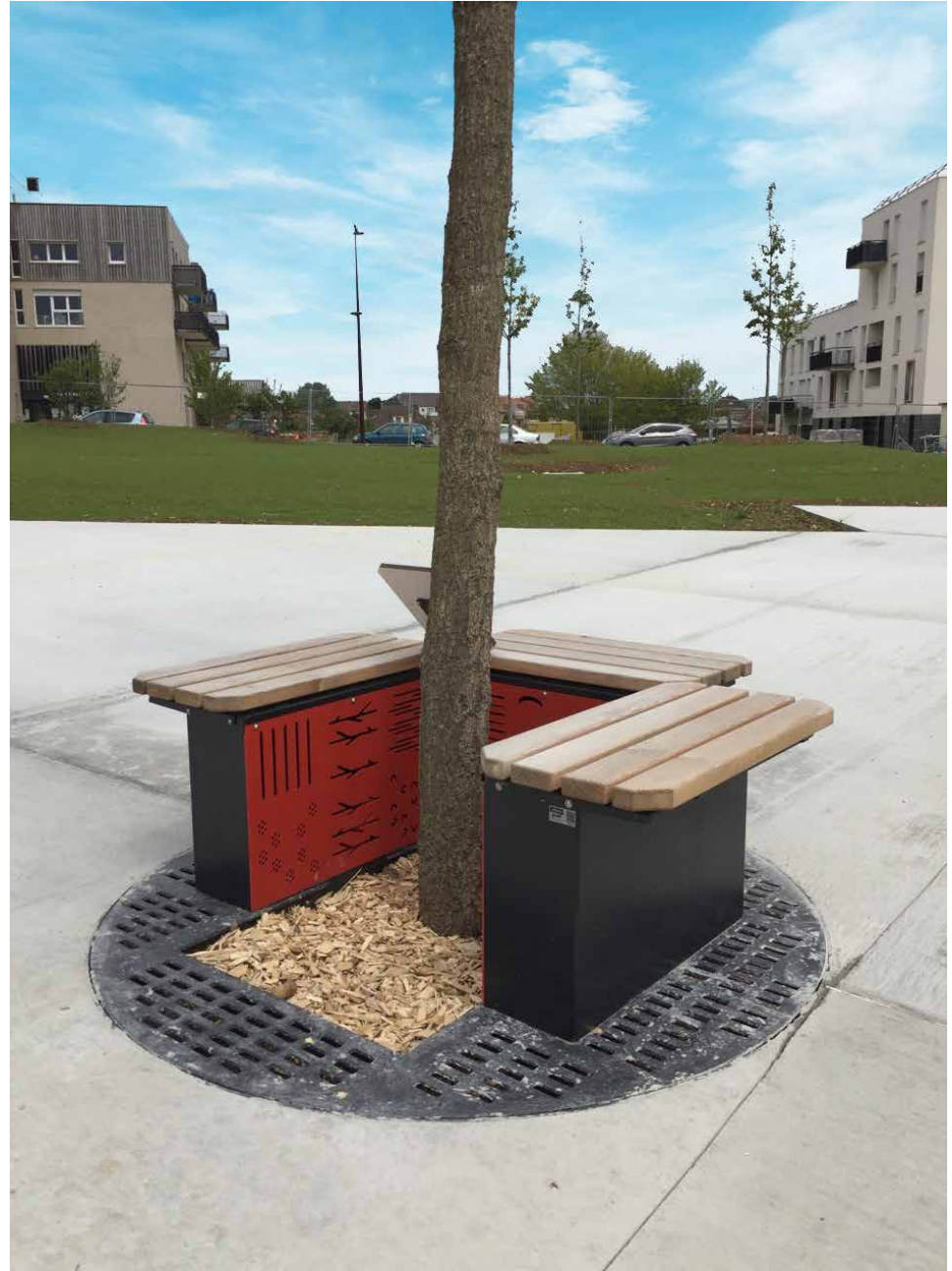

**Refuge bench®**  
Louviers - 27 - France

**Refuge bench®**  
Strasbourg - 67 - France





**Mote**  
Strasbourg - 67 - France

**Refuge bench®**  
Mennecy - 91 - France



**Refuge bench®**  
Mulhouse - 68 - France



**Mote**  
Bagnolet - 93 - France



# Clean city

## A litter-free environment

In an ideal world, everyone decks out their domain in style, creating the perfect, unblemished paradise. The discreet presence of furniture that's all about cleanliness takes on pivotal importance for those who promote the civic ethic. In this perfect world, public places are conceived as havens of interaction, promoters of shared harmony. Thanks to interactive digital tools, such as connected litter bins, ecology blends into everyday life, promoting seamless waste management. And so, looking after our environment, we trace the steps of a healthy, sustainable future.



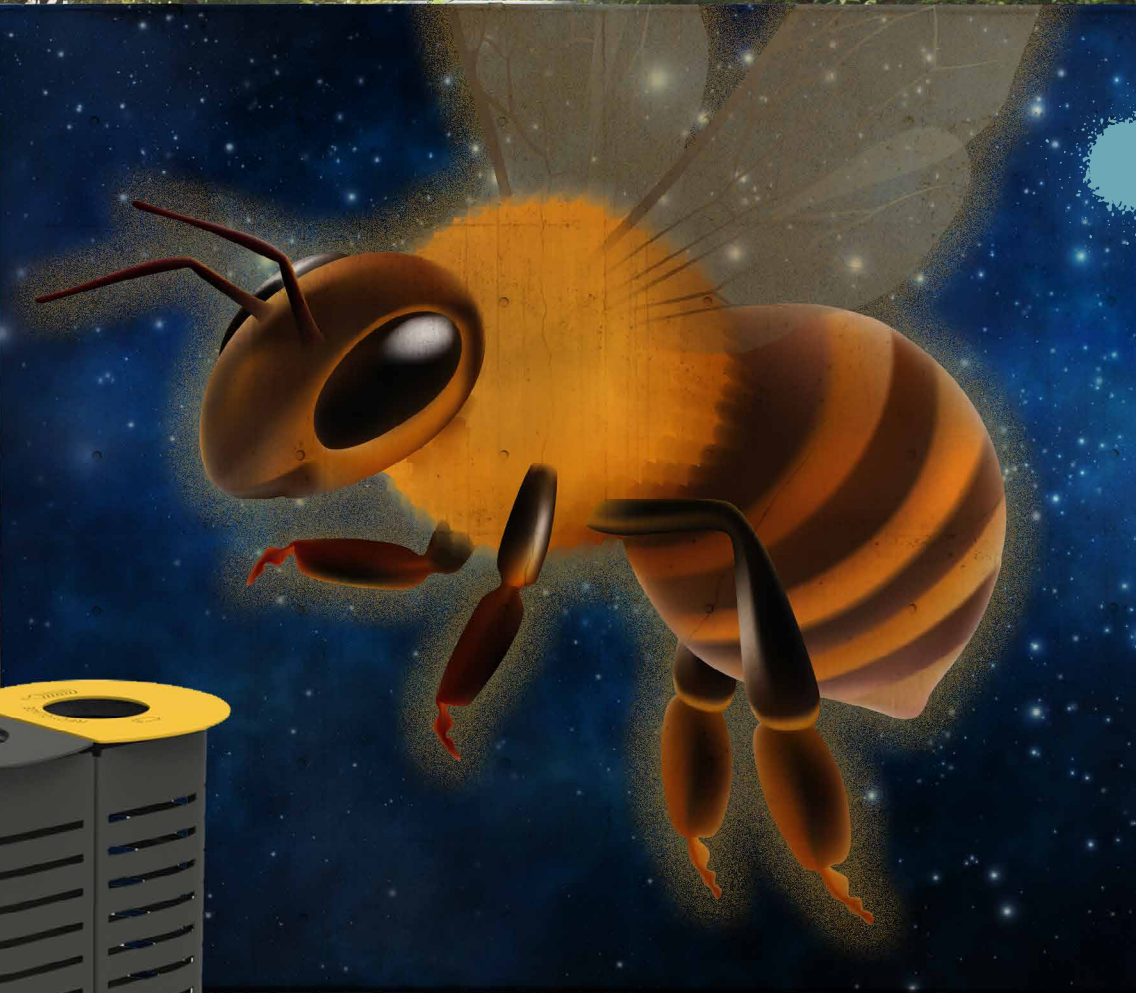

Contemporary Evolution double stream

# Easy Grip®

Unique patented bag grip system  
European patent No. EP 3 592 666



To make the work of bin operatives easier and help them save time when changing bags from their bins, we have invented the Easy Grip system, a unique bag clamping system.

**Easy** because handling is easy, simple, fast and ergonomic.

**Grip** because the bag is properly held after the operation thanks to the lid and the gripping of the bag.

## Installing the waste bag

**1** Lid opening



**2** Placing the bag on the hoop of the bag holder



**3** Closing the lid



**4** The **rounded tips** around the cover cap fit into the holes located in the hoop of the bag holder.

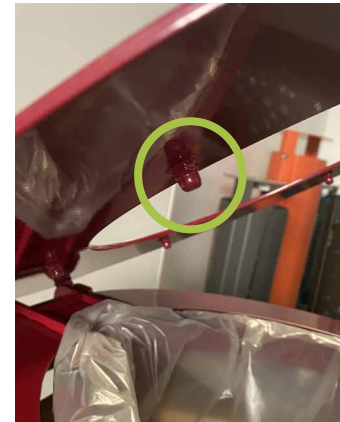

**5** Closing the lid on the bin liner holder **locks the waste bag** and **ensures it's held in place.**



## Advantages

- Time saving
- Operator safety
- Less handling
- Less risk of tearing the bag
- No breakage of the rubber strap
- Less maintenance



## Highlights

- Secure and barrier-free bag edging
- Ergonomic opening
- Easy, natural gripping of the bag
- Tool-free handling
- Optimised emptying time
- Aesthetic finish thanks to the lid
- Less maintenance

## Removing the waste bag - Easy model with front opening

**1** Lid opening



**2** Removal of the bag from below

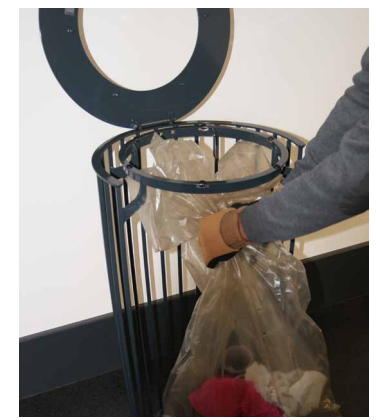

**i** **Availability**

The Easy Grip system is available on all the Easy litter bins with lid, the Contemporary litter bin with bag holders, the new oblong litter bin, Reliefs litter bins and Link litter bins.



# Sorting shelters

**Design:** Sineu Graff

**Materials:**

Zinc and powder coated steel

Sorting plates in zinc and powder coated steel or HPL

Sorting shelters can be placed individually or assembled together.  
They are available in 240 L, 360 L or 660 L.

The steel plates are laser-cut according to required type of sorting.

The HPL signage panel is customisable according to the type of waste to be sorted.

**Customizable signage**

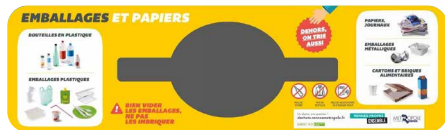
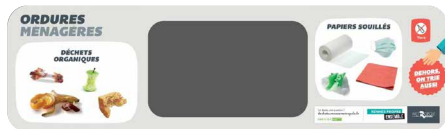

**A single opening.**  
**The addition of an HPL plate identifies the sorting system.**

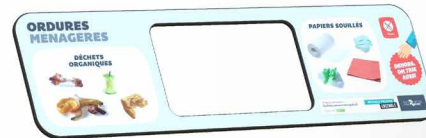

**Depending on use,**  
**the HPL plate can be changed**  
**for a new sorting option.**



Patterns



Evolution

Bamboo

Roots

Graphic

Pebbles

# Sorting shelters

Design: Sineu Graff

Materials:

Zinc and powder coated steel

Sorting plates in zinc and powder coated steel or HPL



**Sorting shelter 240 L**  
Ref. 61 0240 TVE

**Sorting shelter 240 L**  
Ref. 61 0240 TDR

**Sorting shelter 360 L**  
Ref. 61 0360

**Sorting shelter 660 L**  
Ref. 61 0660

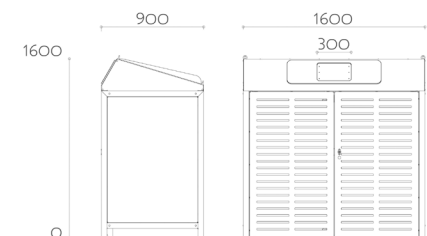
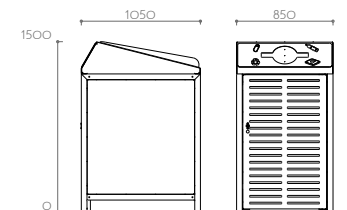
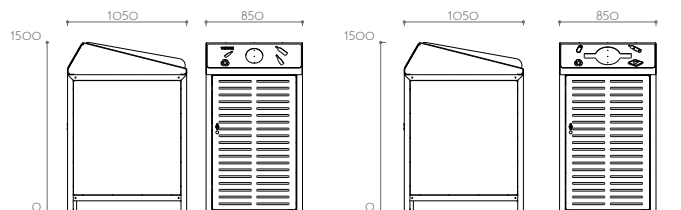

# Selective sorting bins

## Materials:

Zinc and powder coated steel  
 Unstained hardwood or larch  
 Bins in stainless or galvanised steel, or bag holders  
 Stainless-steel ashtray / cigarette snuffer

## Double stream models

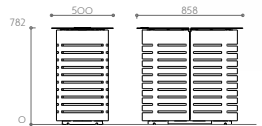

**Contemporary Evolution with flat lid**  
 2x 100L  
 Ref. 20 0755 POE0 0000 TR

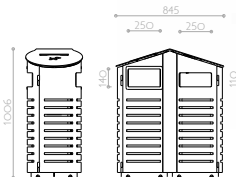

**Contemporary Evolution with sloping lid**  
 2x 70L  
 Ref. 20 0746 B2C0 0F10 TR

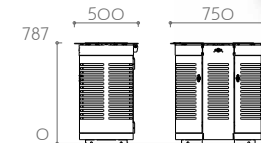

**Contemporary with flat lid**  
 2x 87.5L  
 20 0724 S100 BF00 TPC

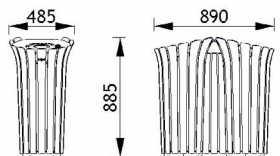

**Tulipe Évolution**  
 2x 70L  
 Ref. 20 0614N ETG TR

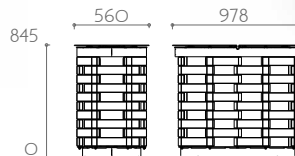

**Reliefs**  
 2x 100L  
 Ref. 20 0320 P000 0000 TR

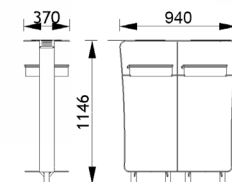

**Diapason**  
 2x 75L  
 Ref. 27 0220 SOE0 0000 TR-TV

# Selective sorting bins

**Materials:**

Zinc and powder coated steel  
 HDPE bag holder or liner (Eidos)  
 Stainless-steel ashtray / cigarette snuffer

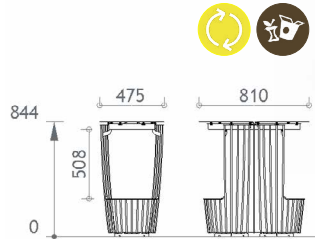

**Easy front collection**  
 2x 100L  
 Ref. 21 1200 S000 00J0 TR

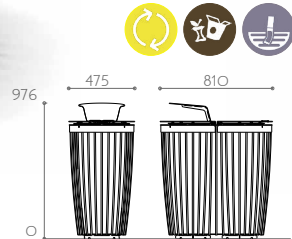

**Easy collection from the top**  
 2x 100L  
 Ref. 21 1210 S0E0 B0JL TR SW

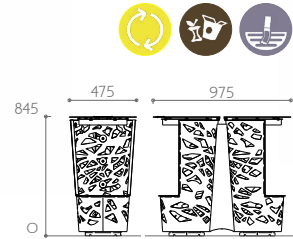

**Easy graphic**  
 2x 110L  
 Ref. 20 1200 S0E0 00JL TR GRA

## Triple stream models

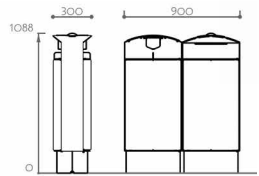

**Eidos**  
 1x 12 L + 1x 44 L | 1x 56L  
 Ref. 20 0420 B2C1 0F00 TR-TV VG3

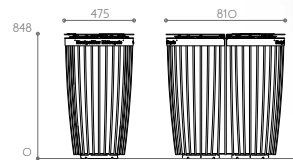

**Easy collection from the top**  
 1x 100L | 2x 50L  
 Ref. 21 1230 S0E0 B0JL TR



**Easy double stream front collection**  
Mennecy - 91 - France

**Tulip Evolution double stream**  
Cahors - 46 - France

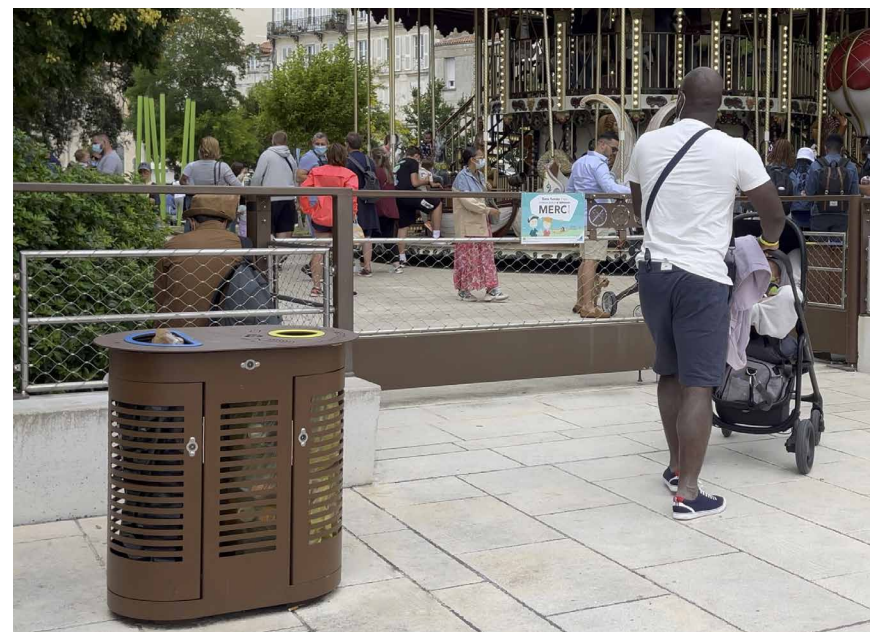

**Contemporary double stream with flat lid**  
La Rochelle - 17 - France

**Link recycling litter bins**  
Saint-Hilaire-du-Touvet - 38 - France





**Sorting shelters**  
Angers - 49 - France

**Sorting shelters**  
Rennes - 35 - France



**Sorting shelters**  
Angers - 49 - France



**Sorting shelters**  
Rennes - 35 - France





**Contemporary Evolution**

95 L - Bag holder - With cigarette snuffer  
Ref. 20 0715 SOEO 0000

# Contemporary with flat lids

**Design:** Sineu Graff

**Materials:**

Zinc and powder coated steel  
 Inner liner in stainless steel  
 or bag holder in zinc and powder coated steel  
 Stainless-steel ashtray/cigarette snuffer

## Features



Lock

Ashtray

Dome ashtray

Cigarette snuffer

Dog bag dispenser

Visibility strip

Half-Moon



## Patterns



Contemporary



Pebbles



Nature



Bamboo



Plus



Graphic



Roots

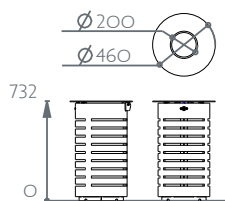

**45 L**  
 Inner liner  
 Ref. 20 0721/20 0711

**70 L**  
 Bag holder  
 Ref. 20 0721 / 20 0711

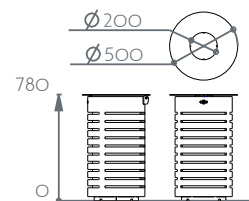

**70 L**  
 Inner liner  
 Ref. 20 0725 / 20 0715

**95 L**  
 Bag holder  
 Ref. 20 0725/20 0715

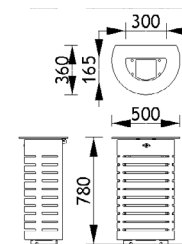

**Half-circle bin 50 L**  
 Inner liner  
 Ref. 20 0723/20 0713

**Half-circle bin 65 L**  
 Bag holder  
 Ref. 20 0723/20 0713

# Contemporary with sloping lids

**Design:** Sineu Graff

**Materials:**

Zinc and powder coated steel  
 Inner liner in stainless steel  
 or bag holder in zinc and powder coated steel  
 Stainless-steel ashtray/cigarette snuffer

**Features**



Lock

Ashtray

Cigarette snuffer

Dog bag dispenser

Visibility strip



**Pebbles**

**Patterns**



**Evolution**



**Plus**



**Bamboo**



**Nature**



**Roots**

**70 L**  
 Inner liner  
 Ref. 20 0735/20 0745

**90 L**  
 Bag holder  
 Ref. 20 0735/20 0745

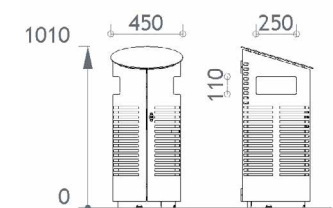



**Contemporary Classic**  
70 L - Inner liner - Front door - With ashtray  
Ref. 20 0735 BICO 0F10



**Contemporary Plus**  
Nice - 06 - France

**Contemporary Evolution**  
Marseille - 13 - France

**Contemporary**  
Bourbourg - 59 - France

**Contemporary with sloping lid**  
With Jumbo® system - Liège - Belgium

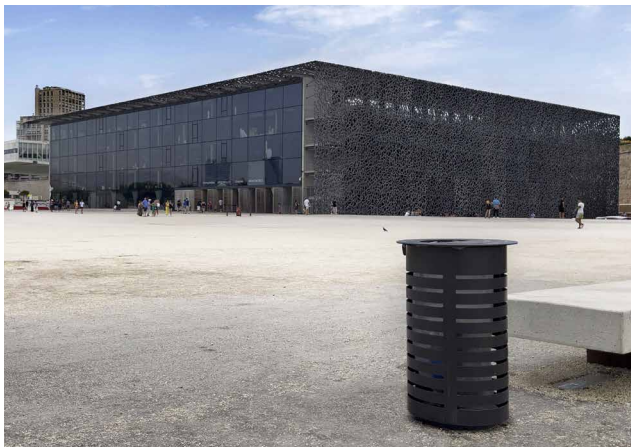



**Contemporary with sloping lid**  
With Jumbo® system® - City of Luxembourg



**Contemporary Pebbles**  
Vinay - 38 - France



**Easy front collection**

With cigarette snuffer and visibility strip  
Ref. 21 1100 SOEO BOJO

**Features**



Without lid with rubber strap

Lid

Visibility strip Customisable on request

Cigarette snuffer

Ashtray

Dog bag dispenser

Anti-rodent basket

Post fixing

# Easy

**Design:** Sineu Graff

**Materials:**

Zinc and powder coated steel

Ashtray, cigarette snuffer and rubber strap

in stainless steel



**Patterns**



**Graphic front collection**

**110 L**

Lid

Ref. 20 1100 S000 00JL GRA



**Front collection**

**110 L**

Sandow and cigarette snuffer

Ref. 21 1100 S0E0 0000



**Double stream front collection**

**2x 100L**

Ref. 21 1200 S000 00J0 TR



**Top collection**

**110 L**

Lid, ashtray and visibility strip

Ref. 21 1110 SOCO B0J0

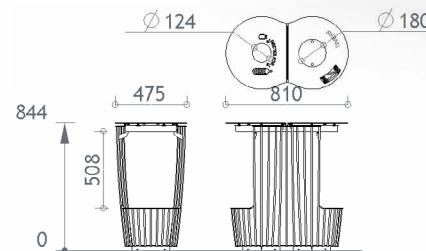
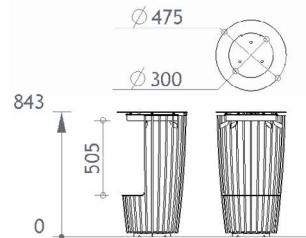
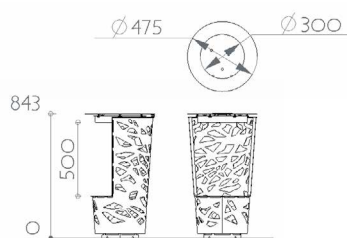

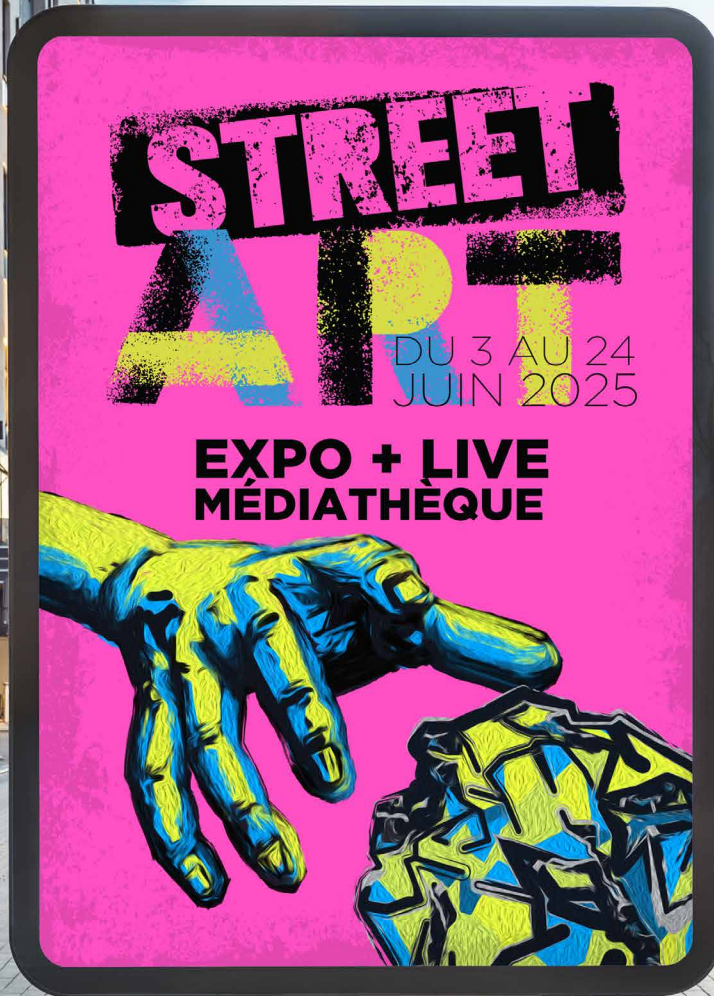

**Tulipe Evolution**  
Ref. 20 0611N

**Features**



With lid

Without lid

Cigarette snuffer

Ashtray

# Tulipe

**Design:** Sineu Graff

**Materials:**

Zinc and powder coated steel  
Galvanised steel Inner liner  
Ashtray/snuffer/lock in stainless-steel



**Double stream Evolution**

Inner liners - 2x 50L - Ref. 20 0615N  
Bag holder - 2x 70L - Ref. 20 0614N

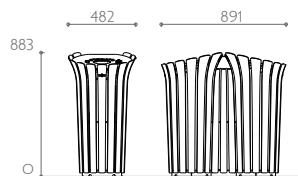

**Evolution**

Inner liner - 70 L - Ref. 20 0610N  
Bag holder - 110 L - Ref. 20 0612N

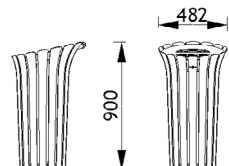

**Evolution**

Inner liner - 50 L - Ref. 20 0611N  
Bag holder - 86 L - Ref. 20 0613N

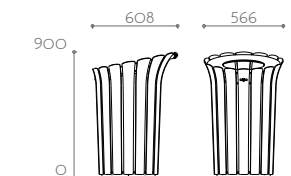

# Eidos

**Design:** Arturo ERBSMAN

**Materials:**

Zinc and powder coated steel  
HDPE inner bins or bag holder  
Stainless-steel ashtray/cigarette snuffer



**Evolution**

Ref. 20 0410  
Inner liner: 56 L  
Bag holder: 70 L

**Features**



Dome ashtray

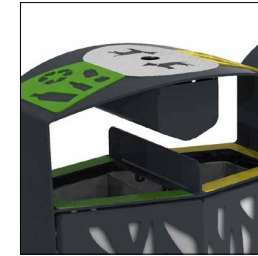

Selective sorting and dog bag dispenser



Post fixing

**Patterns**



**Triple stream Foliage pattern**

Ref. 20 0421 / 20 0422  
Inner liners: 56 L / 44 L + 12 L  
Bag holders: 70 L / 2 x 35 L



**Double stream without cutouts**

Ref. 20 0410  
Inner liners: 44 L + 12 L  
Bag holder: 2x 35L



**Plant pattern**

Ref. 20 0410  
Inner liner: 56 L  
Bag holder: 70 L

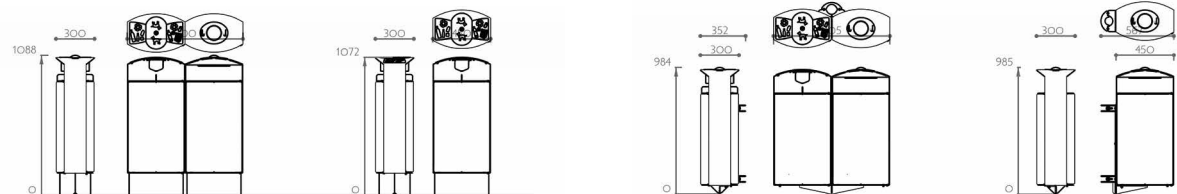

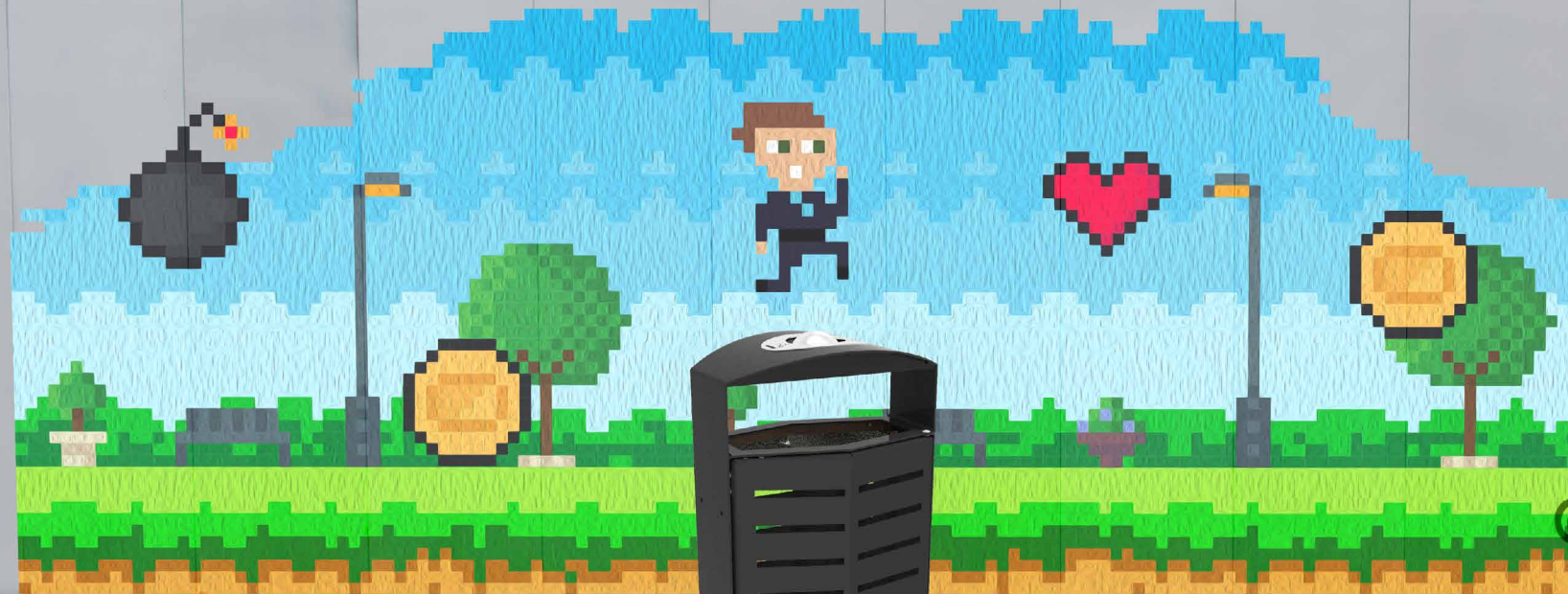

©GTH

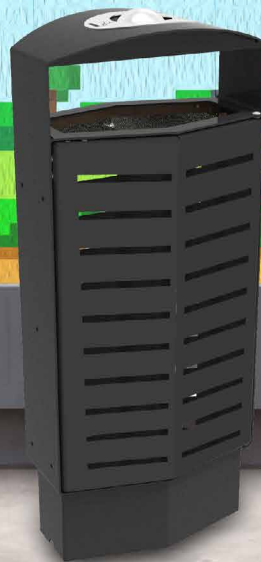

**Eidos Evolution**  
With dome ashtray  
Ref. 20 0410

# Wood litter bins

## Materials:

Zinc and powder coated or galvanised steel  
Some cast aluminium lids  
Wood: autoclave ash, stained  
or unstained hardwood,  
unstained larch (depending on models)

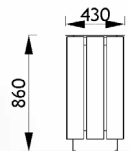

## Link

Bag holder:  
Top opening 102 L - Ref. 11 0585  
Front opening 80 L - Ref. 11 0580  
or liner:  
60 L - Ref. 11 0581

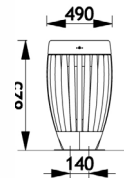

## Rendez-vous

Stainless steel Inner liner:  
55 L - Ref. 20 0800 E  
or bag holder:  
60 L - Ref. 20 0801E

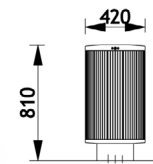

## Round wood

Inner liner:  
48 L - Ref. 20 0567  
58 L - Ref. 20 0569  
or bag holder:  
53 L - Ref. 20 0566  
64 L - Ref. 20 0568

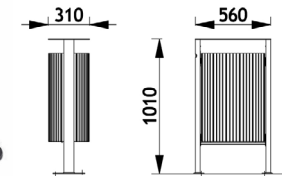

## Oblong wood

With rainshield  
Inner liner:  
38 L - Ref. 20 0553N  
46 L - Ref. 20 0557N  
or bag holder:  
42 L - Ref. 20 0552N  
50 L - Ref. 20 0556N



## Reliefs

Inner liner:  
70 L - Ref. 20 0310  
Bag holder  
95 L - Ref. 20 0310

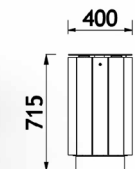
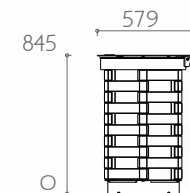

## Square wood

Inner liner:  
42 L - 20 0561 SR  
59 L - 20 0563 SR

**Features**



Rainshield

Cigarette snuffer

Ashtray

Lock

On base plates or to be buried

# Oblong litter bins

**Design:** Sineu Graff

**Materials:**

Zinc and powder coated steel  
Stainless steel inner liner or bag holders  
Ashtray/snuffer/lock  
in stainless steel



**Pattern**



**Bamboo**



**Pebbles**



**Diamant Point**



**Evolution**  
Ref. 20 2526

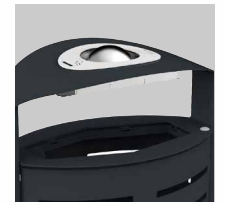

Dome ashtray

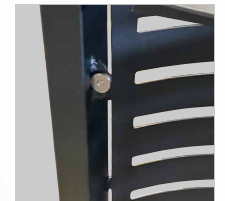

Closing magnet

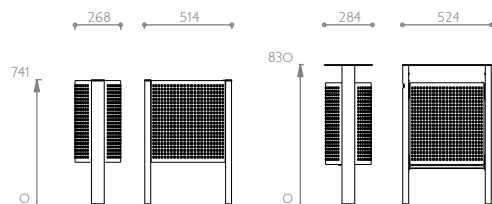

**Inner liner**

38 L - 46 L - 65 L  
Without or with rainshield

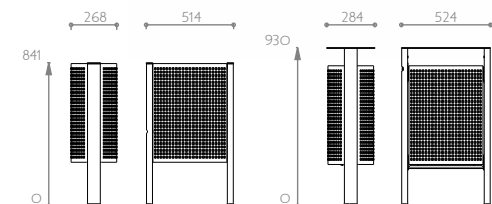

**Bag holder**

42 L - 50 L - 70 L  
Without or with rainshield



**Tulipe Evolution**  
Bellegarde-en-Valserine - 01 - France



**Eidos Foliage**  
Monaco

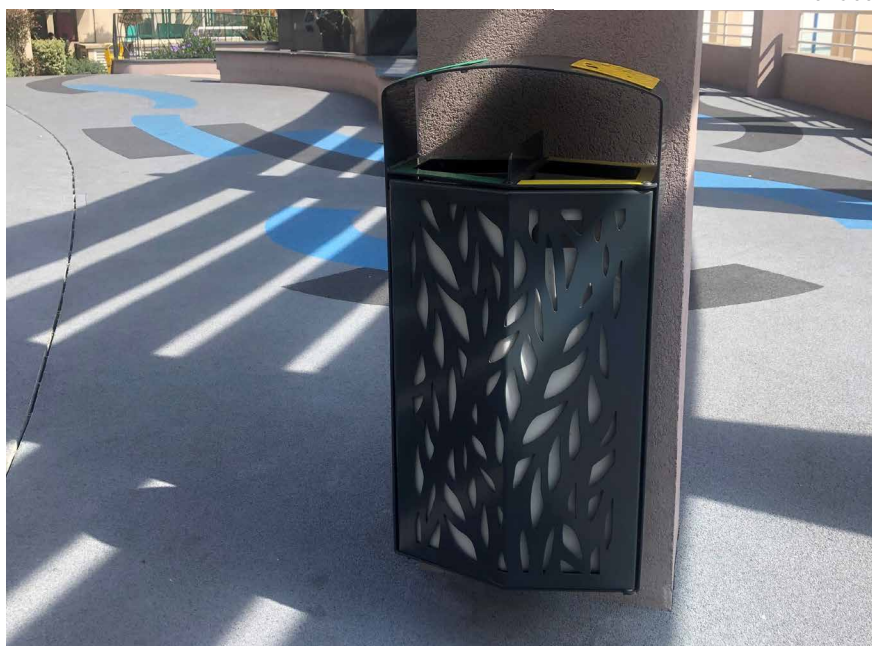

**Tulipe Evolution**  
Bagnolet - 93 - France

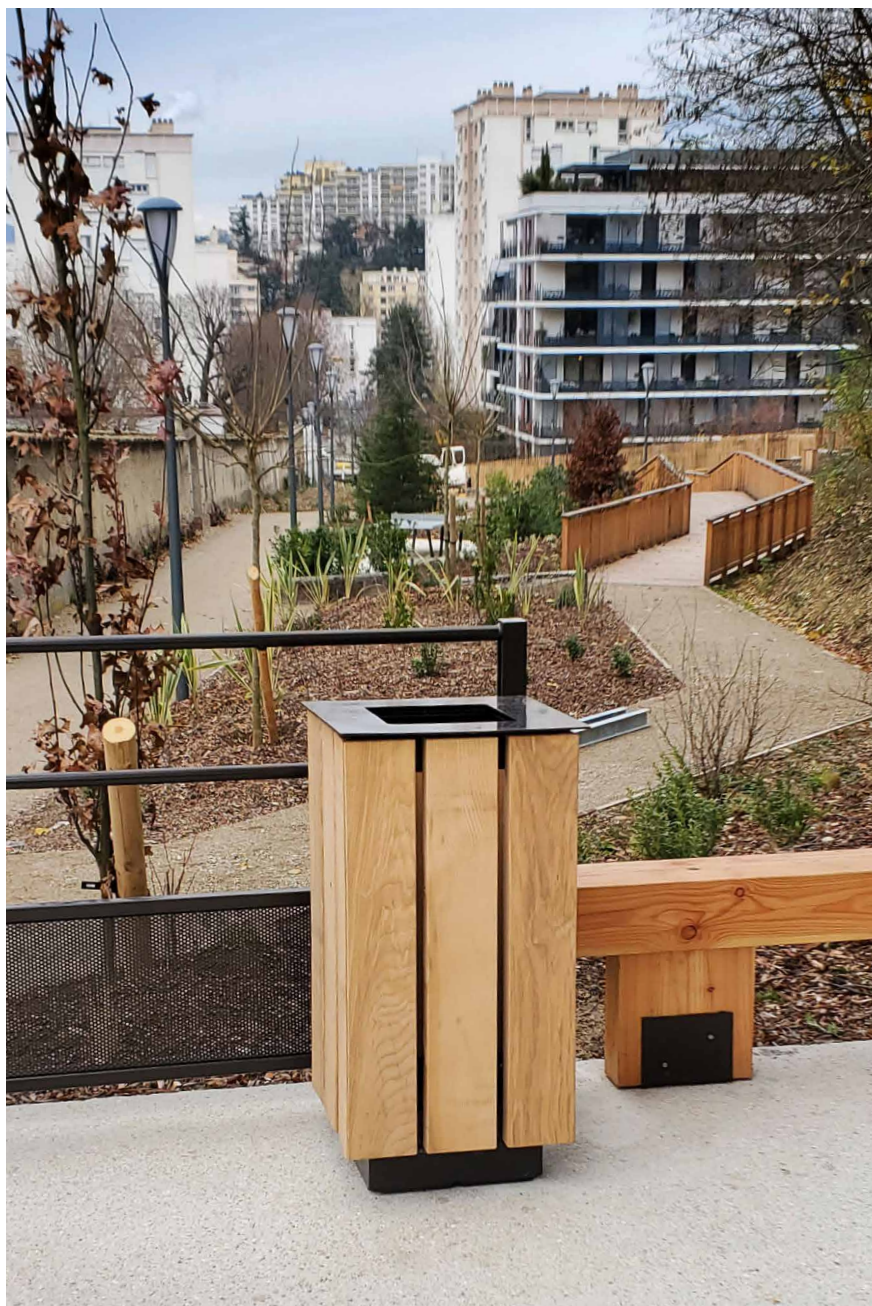

**Link**  
Lyon - 69 - France

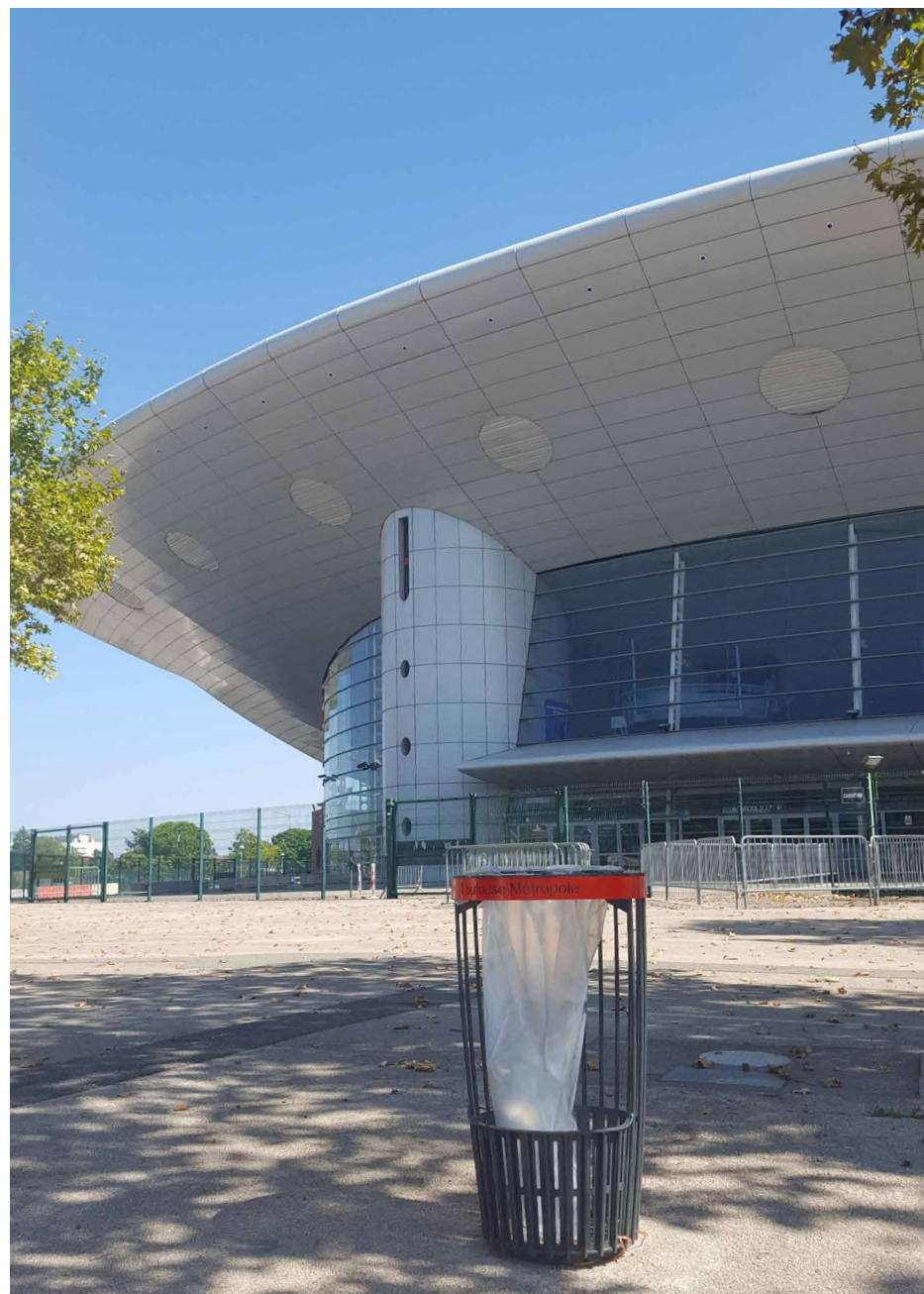

**Easy**  
Toulouse - 31 - France

# City litter bins

**Design:** Sineu Graff

**Materials:**

Zinc and powder coated steel  
 Stainless steel inner liner or bag holders  
 Ashtray/snuffer/liner in stainless-steel  
 Some painted cast aluminium lids



**Garden City**

Bag holder:  
 36 L - Ref. 21 0230  
 60 L - Ref. 21 0210

or inner liner:  
 31 L - Ref. 21 0220  
 50 L - Ref. 21 0200

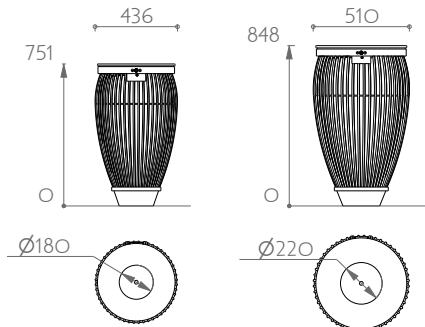

**City round**

Inner liner  
 60 L - Ref. 21 0569

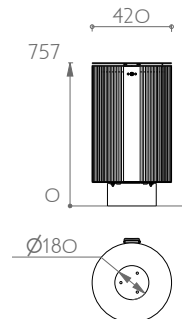

**City square**

Inner liner  
 42 L: Ref. 21 0561 M  
 60 L: Ref. 21 0563 M

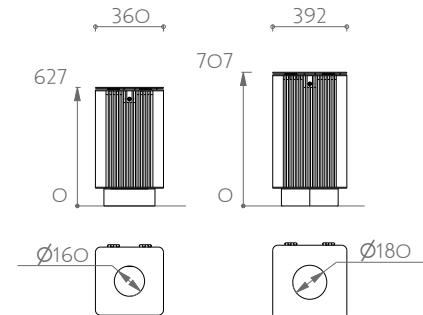

# Bag holders

**Design:** Sineu Graff

**Materials:**  
Zinc and powder coated steel



Rainshield option

## Double stream Contemporary 2 x 110 L

On base plate  
Ref. 27 0101 PLA

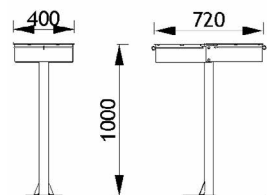

Rainshield option

## Contemporary 110 L

On base plate  
Ref. 27 0100 PLA

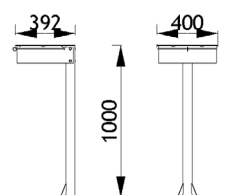

## Diapason 75 L

With cigarette snuffer  
To be to be buried: Ref. 27 0200  
On base plate: Ref. 27 0201

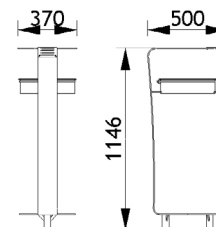

## Double stream Diapason 2x 75L

With cigarette snuffer  
To be to be buried: Ref. 27 0220 SOEO 0000 TR-TV  
On base plate: Ref. 27 0221 SOEO 0000 TR-TV

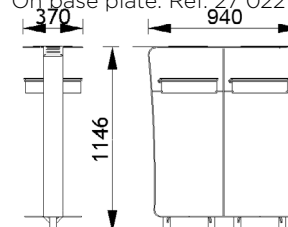

# M5 ASHTRAYS

**Design:** Sineu Graff

**Materials**

Zinc and powder coated steel

Lid, snuffer and lock in stainless steel

Wall fixing, on an existing post or on a supplied post (to embed or on a base plate).



**Wall ashtray - 5 L**

- 1 - Ref. 26 0200 MOEO 0000
- 2 - Unibody communication medium  
Ref. 26 0200 MOEO 0020
- 3 - Visibility banner, display panel and lock  
Ref. 26 0200 M1EO B010

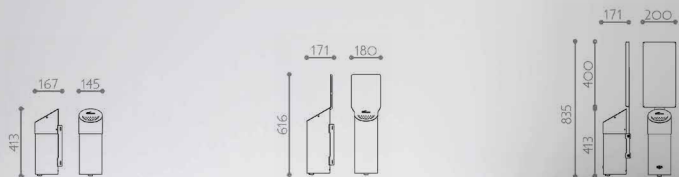

**Ashtray on post - 5 L**

- 4 - Ref. 26 0200 P0EO 0000
- 5 - Flag - Ref. 26 0200 E0EO 0F00
- 6 - Band, flag, display panel and lock  
48 Ref. 26 0200 E1EO BF10

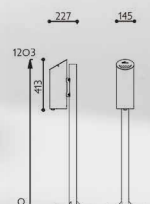

•5

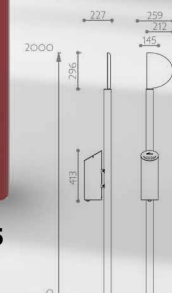

•6

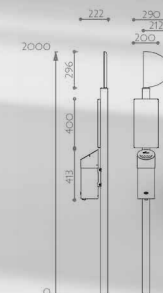

# Ashtrays

**Design:** Sineu Graff

**Materials:**

Zinc and powder coated steel  
Lid, snuffer and lock in stainless steel

## Contemporary ashtrays



**Wall fixing**  
**5 L**

Ref. 25 0102 MUR



**Post fixing**  
**5 L**

Ref. 25 0102 PLA  
Ref. 20 0102 PLA



**Ground fixing**  
**16 L**

Ref. 20 0101 CEND



**Ground fixing**  
**2 L**

Ref. 25 0150 PLA

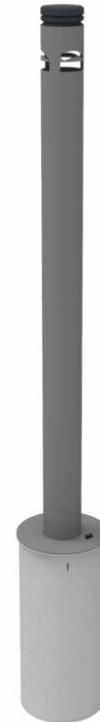

**Ashtray with  
to be buried container**

40 JUMBO 5240  
40 JUMBO 5050.P  
40 JUMBO 2120/2220/2320

## Litter bins with ashtrays



**Wall fixing**

Ashtray 2.5 L  
Litter bin 9,5 L  
Ref. 20 0101 MUR

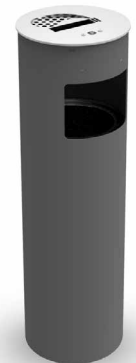

**Ground fixing**

Ashtray 2.5 L  
Litter bin 16 L  
Ref. 20 0101

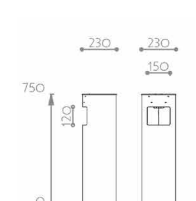
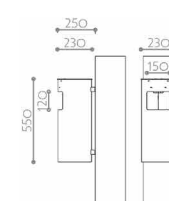
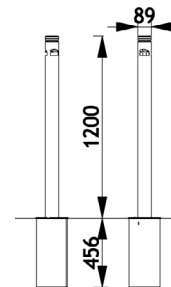
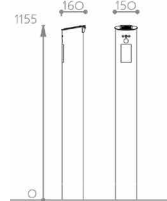
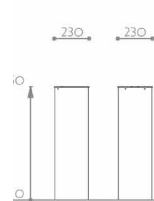
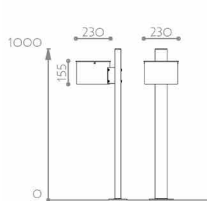
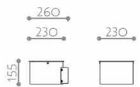

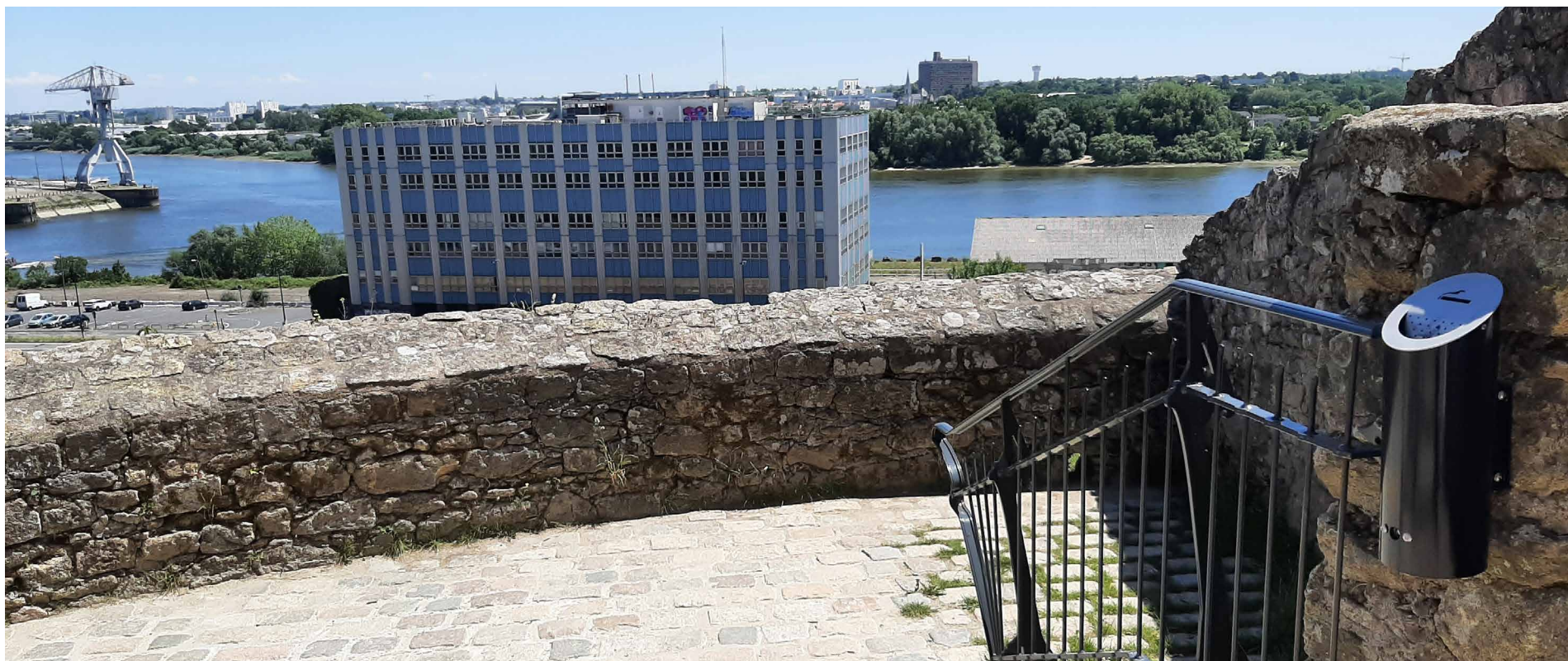

**M5 ashtray wall fixing**  
Nantes - 44 - France

**Urban ashtray**  
Le Lude - 72 - France



**Litter bin with ashtray**  
Obernai - 67 - France



**M5 ashtray on existing post**  
Melun - 77 - France





**M5 ashtray on post**  
Nantes - 44 - France



**M5 ashtray on post**  
Mulhouse - 68 - France

**Litter bin with ashtray**  
Shopping centre reception

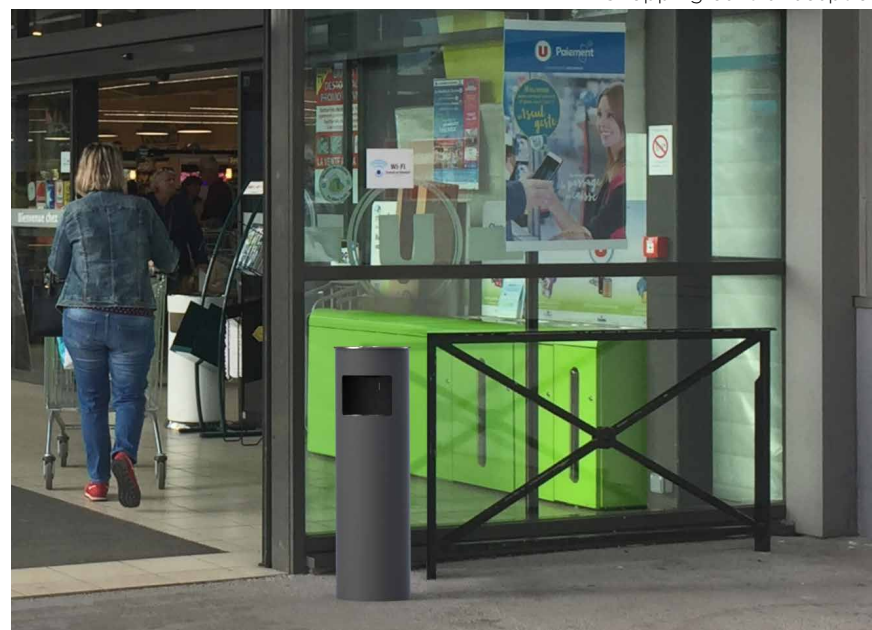

# Jumbo® - The patented to be buried tank system

**1** = **750L**  
**Waste bin**      **capacity**

## Adjustable suction flap

The suction flap is made from galvanised steel. It is non-slip and fitted with an automatic stainless steel lock.

## A litter bin

Litter bin attached to the Jumbo® with an anchoring ring. Other models which can be adapted to the cleanliness system are available.

## Adjustable anchoring ring

Made from galvanised steel.

## To be buried part

## A Jumbo® container

The Jumbo® is a 750 litre to be buried watertight container made from galvanised steel. It is fitted with four handling rings.

“Workers would like to see Jumbo® everywhere, as there would be no more contact with bags (and therefore waste) and no time wasted changing bags...”

**M. GARCIA - Marseillan**  
**General Manager of technical services**



**Jumbo® system**  
Metz - 57 - France



**Contemporary jumbo® litter bin**  
La Rochelle - 17 - France

**Contemporary jumbo® litter bin**  
City of Luxembourg





## With i-apps, enter the smart city!

i-apps is an intelligent urban cleanliness platform to:

- geolocate and supervise all your litter bin equipment
- manage your collection rounds
- efficiently deal with reports and interventions to be carried out
- communicate within your municipality

## i-apps benefits

### FOR YOUR MUNICIPALITY:



#### Peace of mind

- complete supervision of the bstock of litter bins and collection rounds
- measuring collection effectiveness
- better internal and external communications
- secure data hosting in France



#### Savings

- optimisation of human resources
- optimal distribution of the stock of litter bins
- better management of overall costs (transport, equipment, teams, etc.)
- control of subcontracting costs



#### Eco-responsible

- reduction in greenhouse gas emissions
- reduction in the number of plastic bags used



### Satisfaction

- having statistical data for communicating with citizens
- improving the work of your agents



### FOR CITIZENS:

- a more attractive city
- feeling of security
- immediate response to citizen requests
- strengthens the feeling of belonging to the city

In partnership with  
**Divalto**

# i-apps

## The connected clean city

### In the field: 3 apps for 3 uses

#### 1 i-collection

The collection agent scans the QR-Code and indicates the filling level of each bin.



#### 2 i-canine

The collection agent scans the QR-Code and takes care of replacing or refilling the rolls.



#### 3 i-intervention

The maintenance agent carries out the intervention planned in advance via the platform.



At the end of their round, the agent places the reader on its base. The data is automatically transferred to the platform via wifi.



### At the office, on the i-apps platform

Check out all the management and operating features



#### i-Jumbo

The patented solution automaticall reading of the filling level



#### Equipment

**Container stock management:** defines the identity, geolocation, management and operation of each container...



#### Stats

**Managing and optimising** activity thanks to Customisable indicators and dashboards



#### Maintenance

**Managing maintenance interventions** whether or not linked to a connected object



#### Round

**Managing teams and collection rounds:** operating resources, distribution over the territory, indicators, anomalies...



#### Sorting

**Managing different types of containers:** dedicated round



#### Graffiti

**Cleaning graffiti:** managing dedicated sensitive areas



#### Bulky items

**Collection of bulky items and illegal dumping:** managing dedicated sensitive areas

# Intimate city

## Set the world to rights in public space

The city bursts with colour and bustle, offering a myriad of activities. Sometimes, lost in the crowd, we seek the essence of precious solitude. Then a haven opens up, pure and silent, full of kindness and indulgence.

Time stands still, this microcosm pulsates.

The green spaces resonate with a village echo, everyone rediscovering their own singularity.

The town takes a seat on a bench, resting from its own movement, weaving a social fabric through the creation of useful diversions.





Grand large



# Nine

Design: Michael HENNEMANN



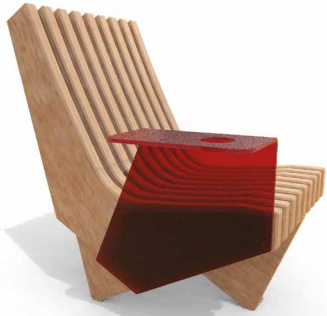

**Armchair**  
Ref. 10 9110  
with armrest Ref. 10 9111



**Short bench 2.50 m**  
Ref. 10 9100

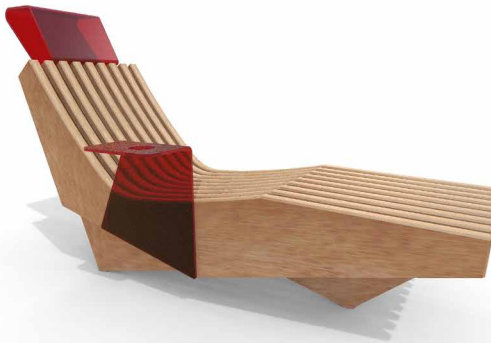

**Lounger**  
Ref. 10 9150  
with armrest and headrest Ref. 10 9156



**Bench 4.50 m**  
Ref. 10 9000

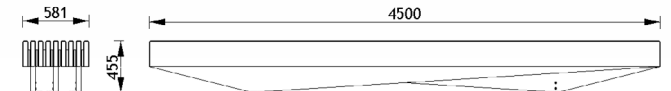
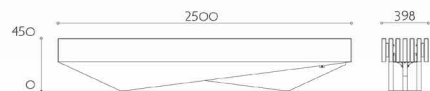
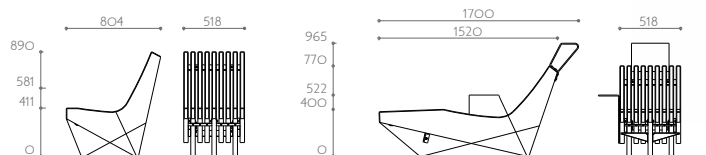

# Nine

**Design:** Michael HENNEMANN

**Materials:**

Laminated unstained hardwood  
Zinc and powder coated steel frame  
Backrest and armrest: Red or grey PMMA



**Seat 4.50m**

10 9003 - with 3 fixed backrests

10 9021 - with 1 fixed and 2 sliding backrests

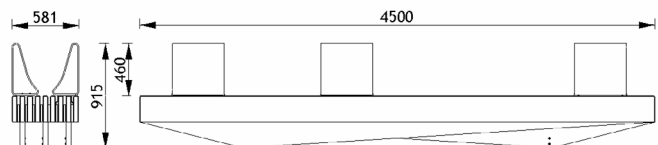



# Arobase

Design: Alexandre MORONNOZ





**Low stool**  
Ref. 16 110X



**Stool**  
Ref. 16 130X



**Small table**  
Ref. 16 150X

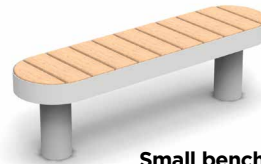
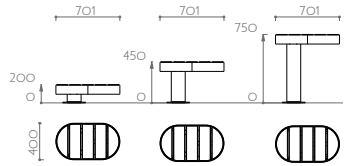

**Small bench**  
Ref. 16 160X

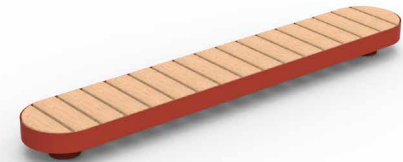
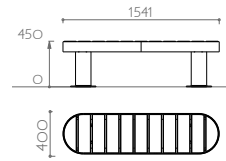

**Low bench**  
Ref. 16 161X

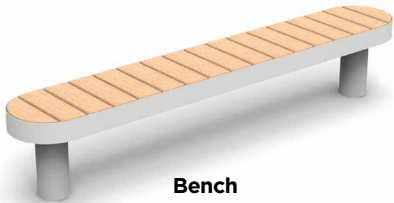

**Bench**  
Ref. 16 162X

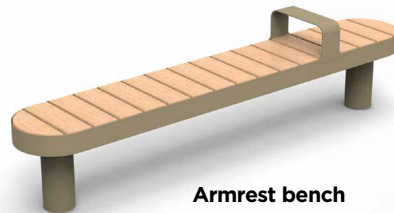
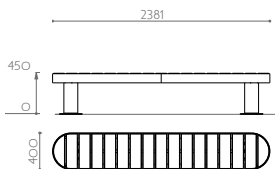

**Armrest bench**  
Ref. 16 163X

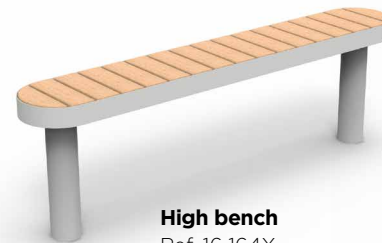
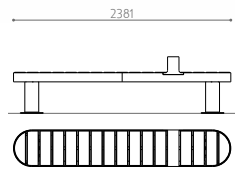

**High bench**  
Ref. 16 164X

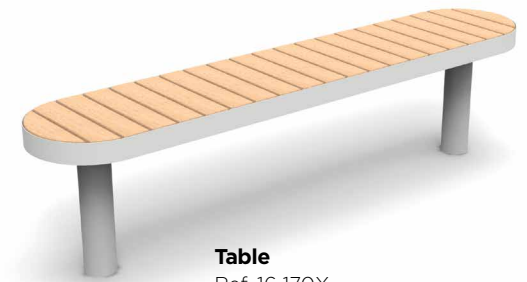
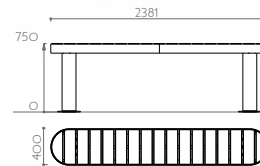

**Table**  
Ref. 16 170X

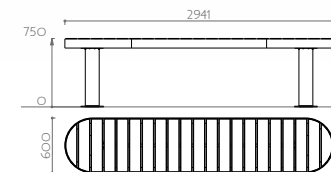

# Arobase wood

**Design:** Alexandre MORONNOZ

**Materials:**

Structure: Zinc and powder coated steel

Seating: Unstained larch or stained or unstained hardwood

Fixing: to be buried or on base plates



## Combinations

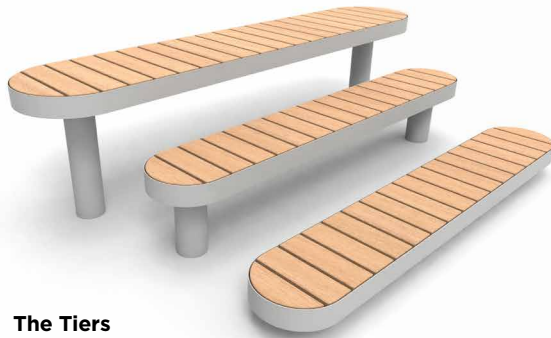

### The Tiers

Ref. 16 C10

Made up of:

- 1 high bench
- 1 bench
- 1 low bench

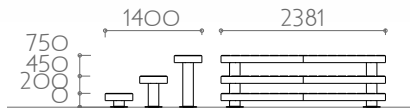

### The Platform

Ref. 16 C09

Made up of:

- 1 table
- 1 bench
- 1 small bench
- 1 stool

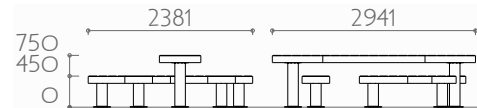

### The Duo Table

Ref. 16 C03

Made up of:

- 1 small table
- 2 stools

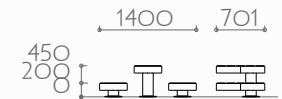

### The Counter

Ref. 16 C05

Made up of:

- 1 bench
- 1 high bench

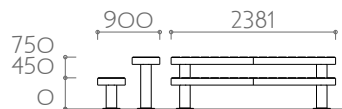

### The Small Table

Ref. 16 C04

Made up of:

- 1 small table
- 1 small bench



### The big table 2

Ref. 16 C07

Made up of:

- 1 table
- 1 bench
- 1 small bench

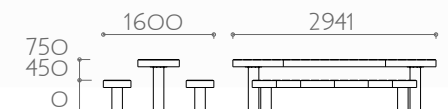

**Large wooden Arobase Table**  
Design simulation

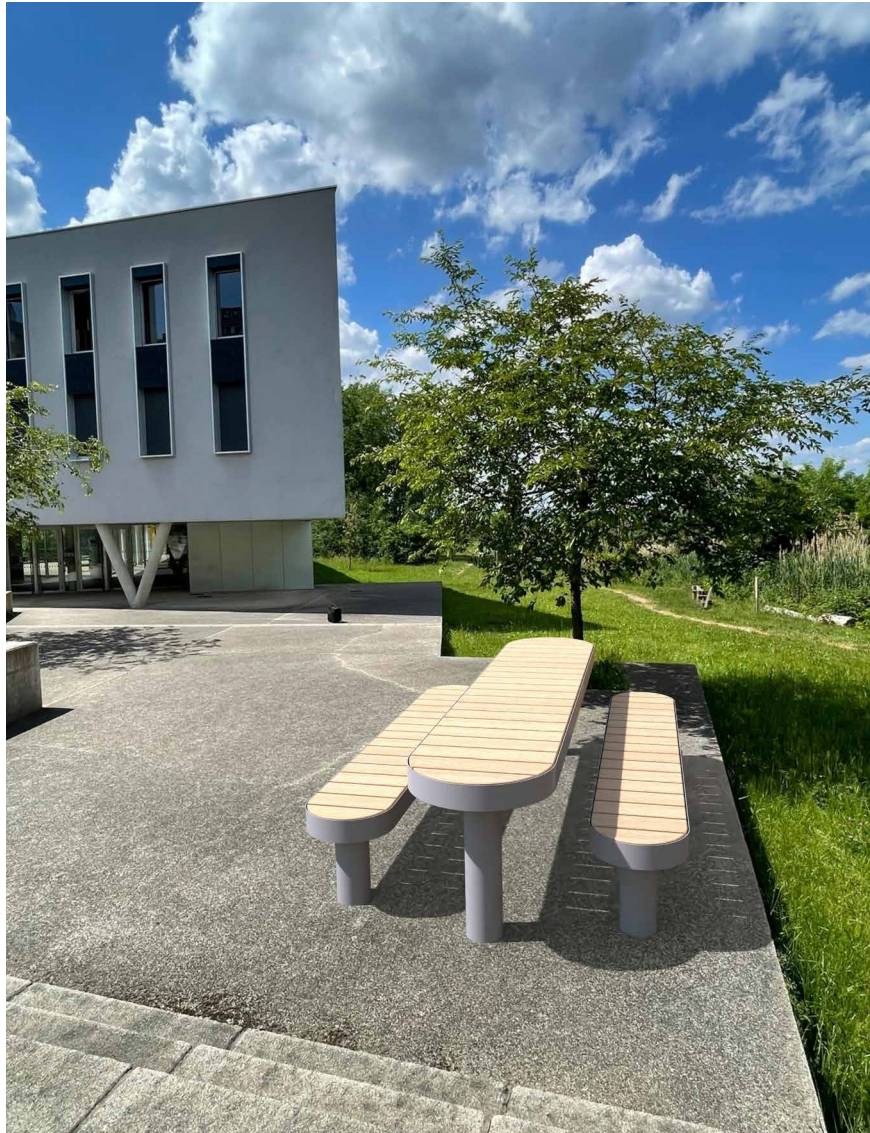

**Arobase**  
Saint-Just-le-Martel - 87 - France

**Arobase**  
Lorient- 56 - France



# Arobase

**Design:** Alexandre MORONNOZ

**Materials**

Structure: Zinc and powder coated steel

Seating: Powder coated cast iron

Fixing: to be buried or on base plates



**Table with cover**  
Ref. 16 051X (Front cover)  
Ref. 16 052X (Rear cover)



**Table**  
Ref. 16 050X



**Seating with backrest**  
Ref. 16 031X (Front backrest)  
Ref. 16 032X (Rear backrest)



**Seating**  
Ref. 16 030X



**Solid seating with backrest**  
Ref. 16 035X (Front backrest)  
Ref. 16 036X (Rear backrest)



**Solid seating**  
Ref. 16 034X

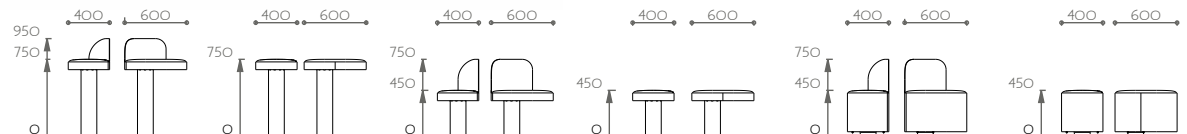

Photo credits: Jérôme GLUZICKI



**Grand Large**  
Calais 62 - France

# Grand Large

**Grand Large**  
Calais - 62 - France

**Design:** Yannick & Camille CLAESSENS-VALLET

Photo credits: Philippe TURPIN

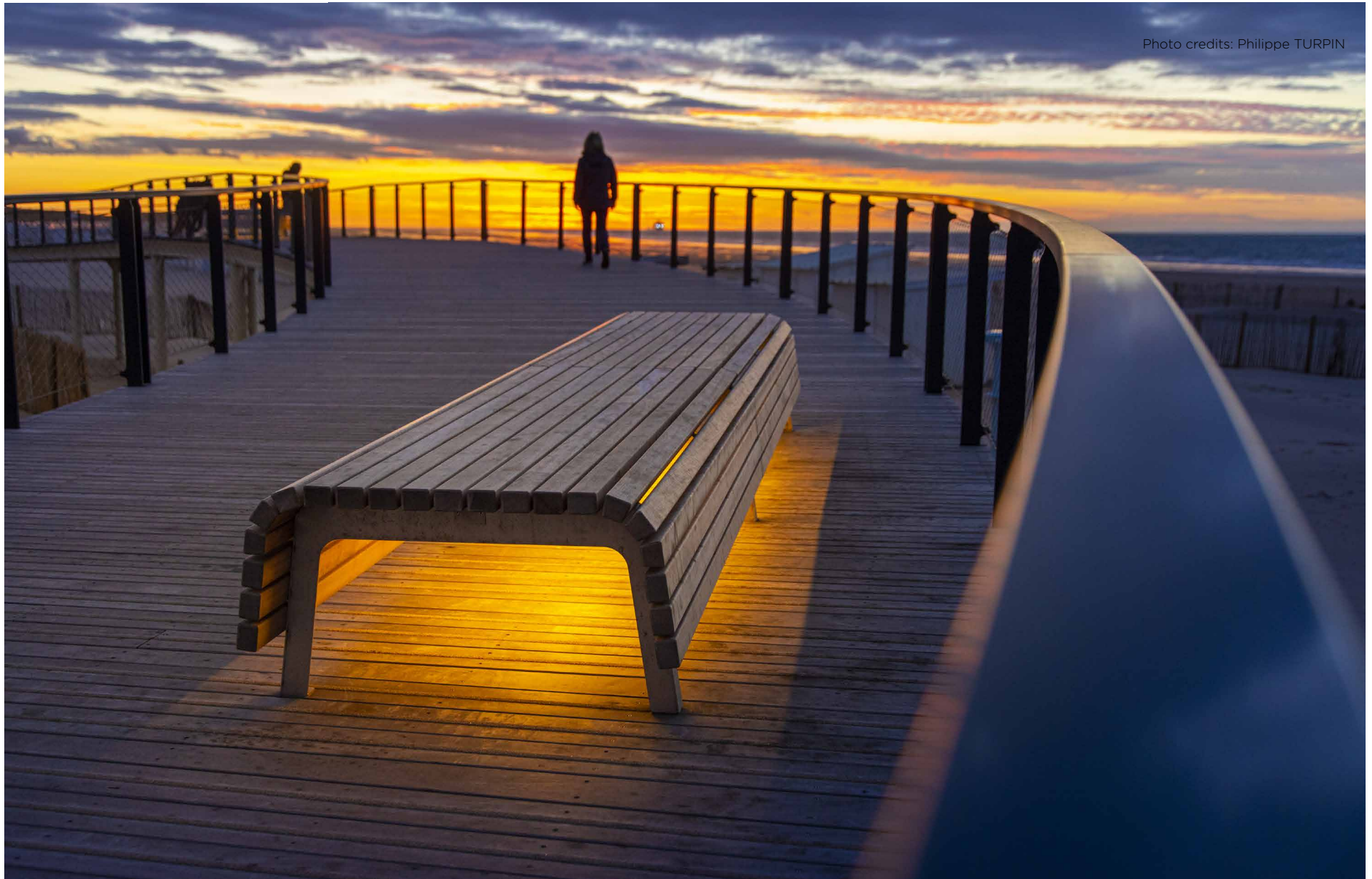

# Grand Large

**Design:** Yannick & Camille CLAESSENS-VALLET

**Materials:**

Galvanised, zinc and powder coated or stainless steel  
 Unstained larch or stained or unstained hardwood



**Available with armrests**



**Large double seat**  
 Ref. 10 7260

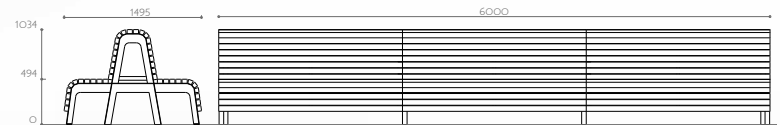

**Stool**  
 Ref. 10 7110



**Bench**  
 Ref. 10 7120

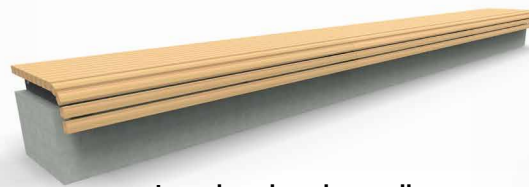

**Long bench on low wall**  
 Ref. 10 7460



**Long bench**  
 Ref. 10 7160



# Grand Large

**Design:** Yannick & Camille CLAESSENS-VALLET

**Materials:**

Galvanised, zinc and powder coated or stainless steel  
Unstained larch or stained or unstained hardwood



**Double lounger**  
Ref. 10 7520

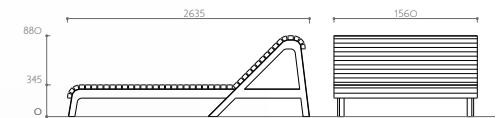

**Sofa**  
Ref. 10 7320

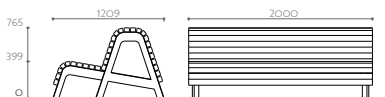

**Lounger**  
Ref. 10 7510

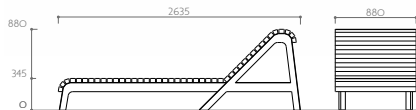

**Picnic table**  
Ref. 10 7820

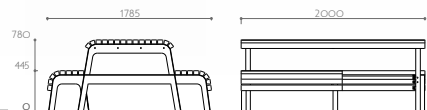

**Banquet table**  
Ref. 10 7860

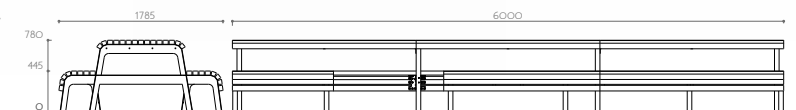



**Street table with sunshade**  
Ribeauvillé - 68 - France

# Link

**Design:** Philippe RIEHLING

**Materials:**

Unstained hardwood or larch, autoclaved ash  
Galvanised or zinc and powder coated steel

**Street table set**

Made up of:  
1 street table + 1 end extension  
4 stools  
3 x 2-seater benches



Pushchair or wheelchair space



**Street table**  
Ref. 11 0510

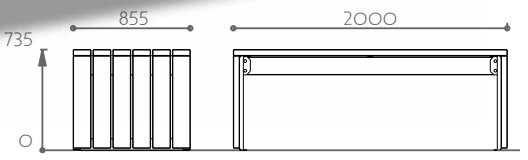

**Bicycle stand**  
Ref. 11 0560

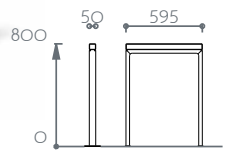

**Litter bin**  
Bag holder:  
Top opening 102 L  
Ref. 11 0585  
Front opening 80 L  
Ref. 11 0580  
or liner 60 L  
Ref. 11 0581

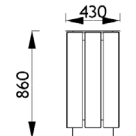

# Link

**Design:** Philippe RIEHLING

**Materials:**

Unstained hardwood or larch, autoclaved ash  
Galvanised or zinc and powder coated steel



Available with armrests



**3-place seat**  
Ref. 11 1508



**3-place bench**  
Ref. 11 0508



**2-place bench**  
Ref. 11 0507



**Stool**  
Ref. 11 0506



**High table**  
Ref. 11 0515

**High bench**  
Ref. 11 0505

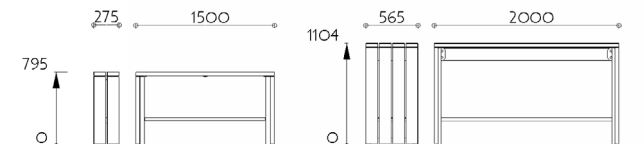
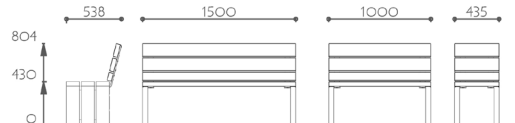
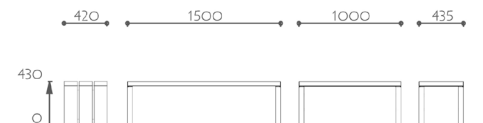

# Link

**Design:** Philippe RIEHLING

**Materials:**

Unstained hardwood or larch, autoclaved ash  
Galvanised or zinc and powder coated steel



**3-place seat**  
Ref. 11 1503



**3-place seat with half backrest**  
Ref. 11 1513



**2-place seat**  
Ref. 11 1502



**Chair**  
Ref. 11 1501



**3-place bench**  
Ref. 11 0503



**2-place bench**  
Ref. 11 0502



**Stool**  
Ref. 11 0501

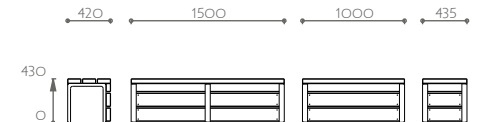

# Link

**Design:** Philippe RIEHLING

**Materials:**

Unstained hardwood or larch, autoclaved ash  
Galvanised or zinc and powder coated steel



**2 x Loungers**  
Ref. 11 1550.P

**2 x Shelves**  
Ref. 11 0555.P



**High table**  
Ref. 11 0530.P

**3 x stand-up seat**  
Ref. 11 0504.P

**Low table**  
Ref. 11 0520.P

**2 x Stools**  
Ref. 11 0501.P

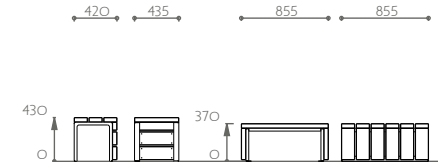
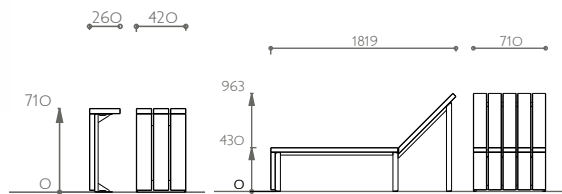
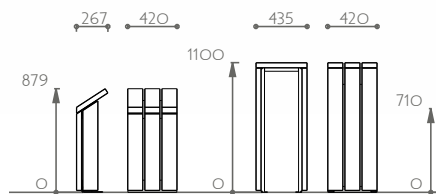

# Link

**Design:** Philippe RIEHLING

**Materials:**

Unstained hardwood or larch, autoclaved ash  
Galvanised or zinc and powder coated steel



**3-panel sunshade**  
Ref. 11 2503.P

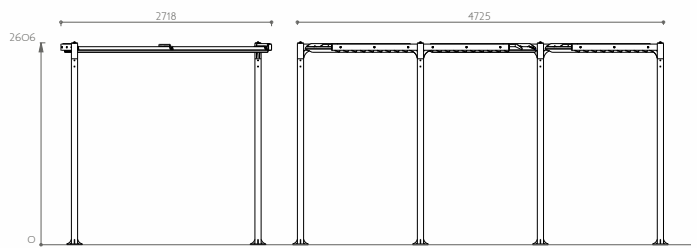



**Street table**  
Ribeauvillé - 68 - France



**Street table**  
Lyon - 69 - France

**Loungers**  
Langesund - Norway



**Street table with sunshade**  
Bègles - 33 - France



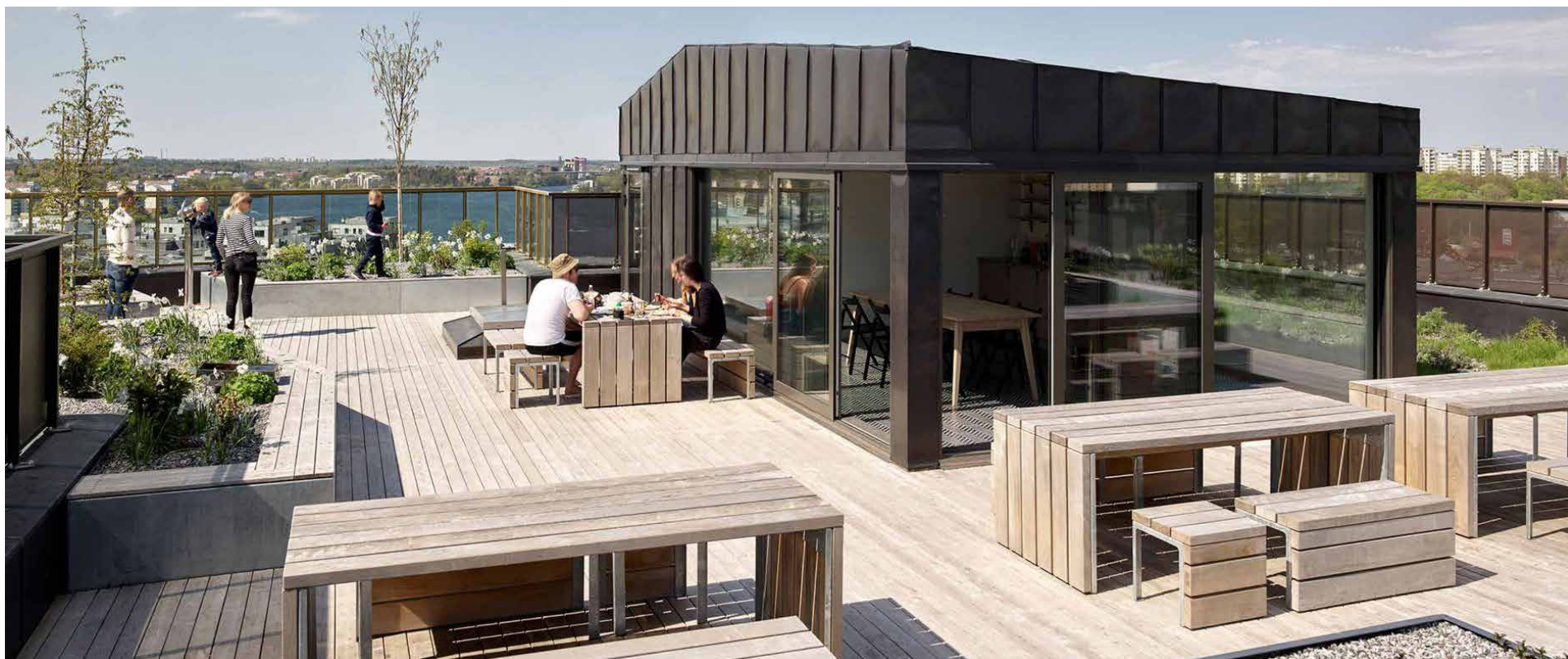

**Street tables**  
Stockholm - Sweden

**Loungers**  
Épinal - 88 - France

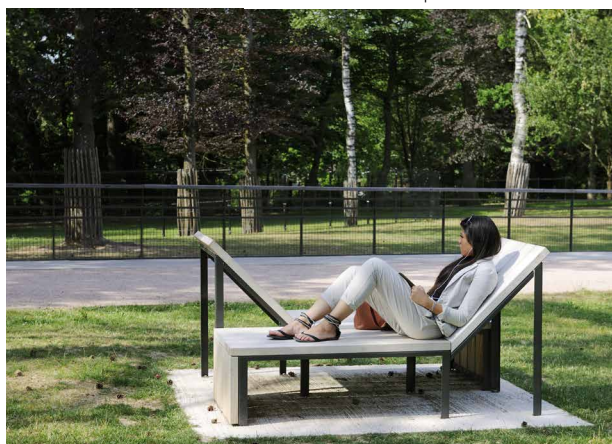

**Children's street table and sunshade**  
Walferdange - Luxemburg



**Stand-up set**  
Limoges - 87 - France





Bobine

# Bobine

**Design:** Coline CHABIRON

**Materials:**

Wood: stained ash, unstained larch or hardwood  
Galvanised steel or zinc and powder coated steel



**Bobine seat**  
Ref. 11 3505.P

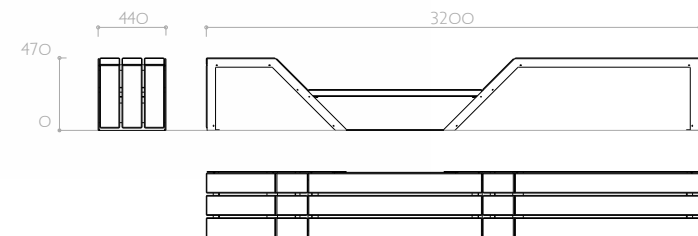

**2 reversed side-by-side modules**



**2 modules side by side**



**2 modules lengthwise**

# Affinité

## Short slats

**Design:** Sineu Graff

**Materials:**

Unstained hardwood or larch, stained ash

Zinc and powder coated steel

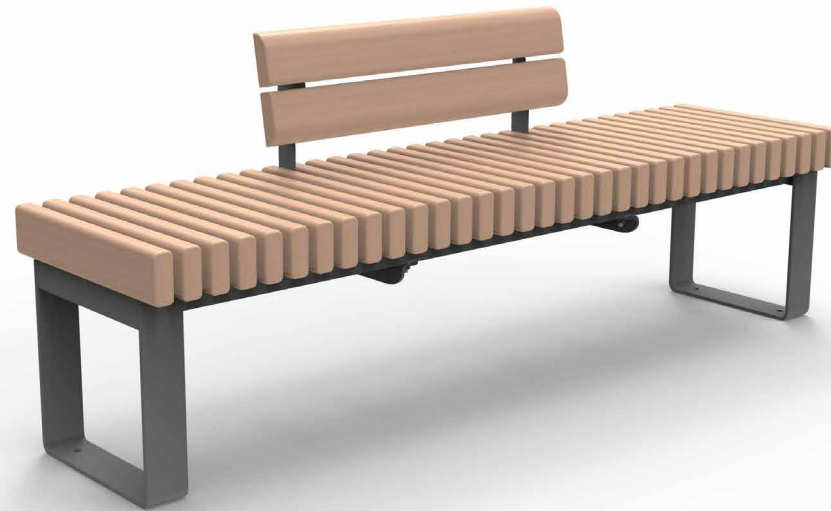

**3-place seat with half backrest**  
Ref. 10 3330

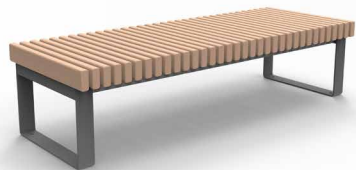

**Wide 3-place bench**  
Ref. 10 3361

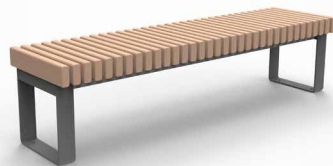

**Slim 3-place bench**  
Ref. 10 3360

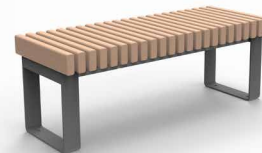

**2-place narrow bench**  
Ref. 10 3350



**Stool**  
Ref. 10 3340

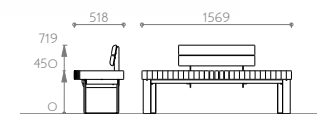
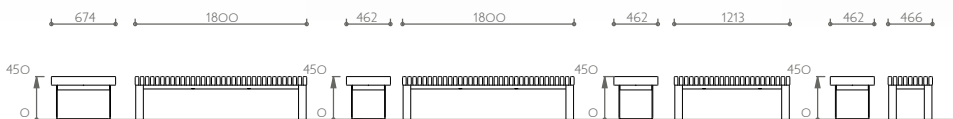

# Affinité

## Long slats

**Design:** Sineu Graff

**Materials:**

Unstained hardwood or larch, stained ash  
Zinc and powder coated steel

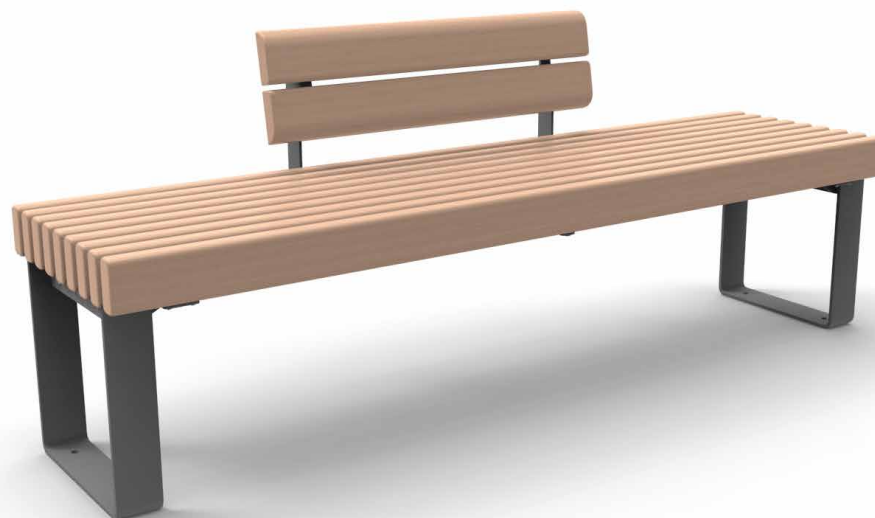

**3-place seat with half backrest**  
Ref. 10 3335

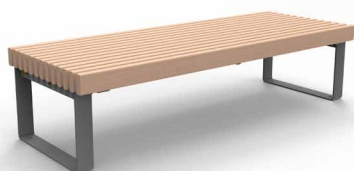

**Wide 3-place bench**  
Ref. 10 3366

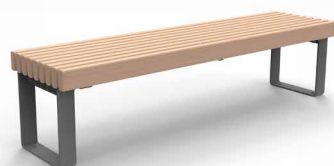

**Slim 3-place bench**  
Ref. 10 3365



**2-place narrow bench**  
Ref. 10 3355



**Stool**  
Ref. 10 3345

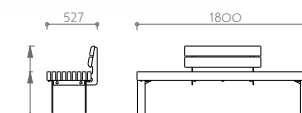
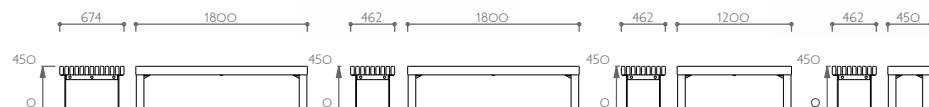



Affinité

# Affinité

## Short slats

**Design:** Sineu Graff

**Materials:**

Unstained hardwood or larch, stained ash

Zinc and powder coated steel

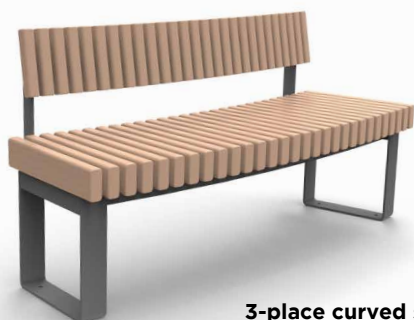

**3-place curved seat**  
 Inner diameter Ø 9.08 m  
 External diameter Ø 10.00 m  
 Ref. 10 3435



**3-place curved seat**  
 Inner diameter Ø 2.12 m  
 External diameter Ø 3.06 m  
 Ref. 10 3436

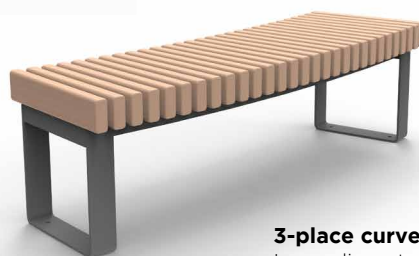
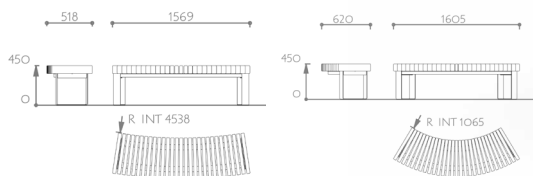
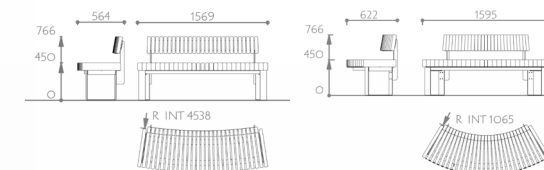

**3-place curved bench**  
 Inner diameter Ø 9.08 m  
 External diameter Ø 10.00 m  
 Ref. 10 3461

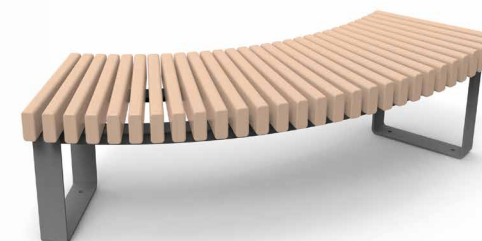

**3-place curved bench**  
 Inner diameter Ø 2.12 m  
 External diameter Ø 3.06 m  
 Ref. 10 3460



**Combination 1**  
 Ref. 10 3480 001



**Combination 6**  
 Ref. 10 3480 004



**Combination 7**  
 Ref. 10 3480 012



**Combination 9**  
 Ref. 10 3490 008

# Idylle

**Design:** Arturo ERBSMAN

**Materials:**

Unstained hardwood or larch, stained ash

Powder coated cast iron



**3-place seat**  
Ref. 10 0183



**Wide 3-place bench**  
Ref. 10 0186



**Slim 3-place bench**  
Ref. 10 0185



**2-place narrow bench**  
Ref. 10 0184



**Armchair**  
Ref. 10 0580

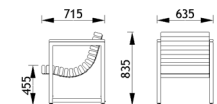
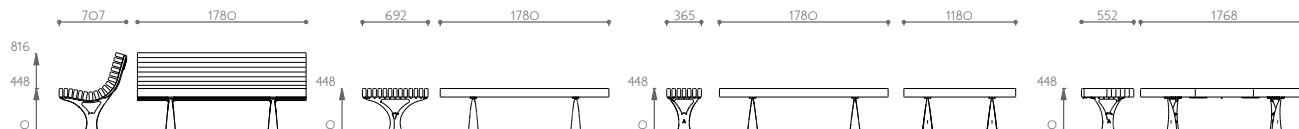

# Idylle

**Design:** Arturo ERBSMAN

**Materials:**

Unstained hardwood or larch, stained ash

Powder coated cast iron



**3-place curved seat**

Inner diameter Ø 2.81 m  
 External diameter Ø 3.54 m  
 Ref. 10 0289

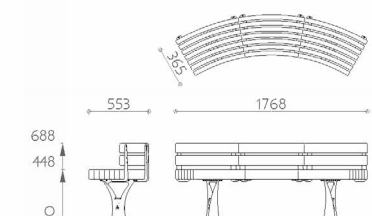

**3-place curved bench**

Inner diameter Ø 2.81 m  
 External diameter Ø 3.54 m  
 Ref. 10 0285

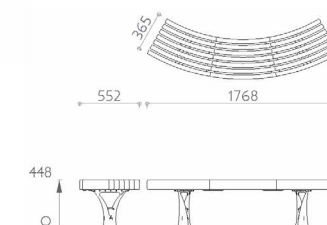

**360° circular bench**  
 Ref. 10 0287 S000



**S-curve bench**  
 Ref. 10 0286 S003



**300° circular bench**  
 Ref. 10 0287 S001



**Curved seat**  
 Ref. 10 0286 S006

# Idylle

**Design:** Arturo ERBSMAN

**Materials:**

Unstained hardwood or larch, stained ash  
Powder coated cast iron



**Picnic set**

Made up of:  
2 high tables and 4 slim 3-place benches



**“Leaves” table**  
Ref. 10 0288



**“Leaves” stool**  
Ref. 10 0283



**High table**  
Ref. 10 0188



**“Fruit” table**  
Ref. 10 0284



**“Fruit” stool**  
Ref. 10 0281

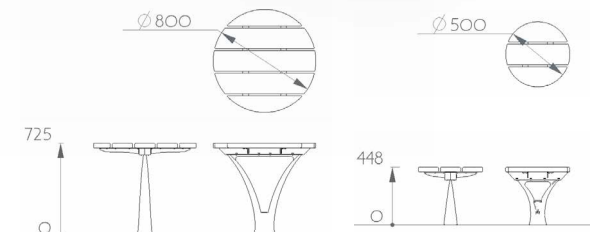
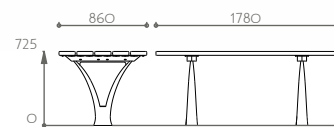
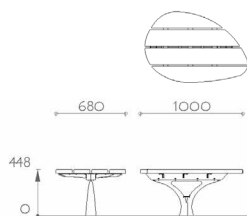
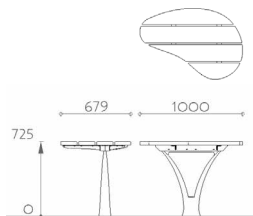



**Picnic set**  
Made up of: 1 high table and 6 fruit stools



**Idylle tree surround**  
Guyancourt - 78 - France



**Idylle picnic set**  
Menthon-Saint-Bernard - 74 - France

**Customized Affinité seat**  
Hoogbrug - Belgium



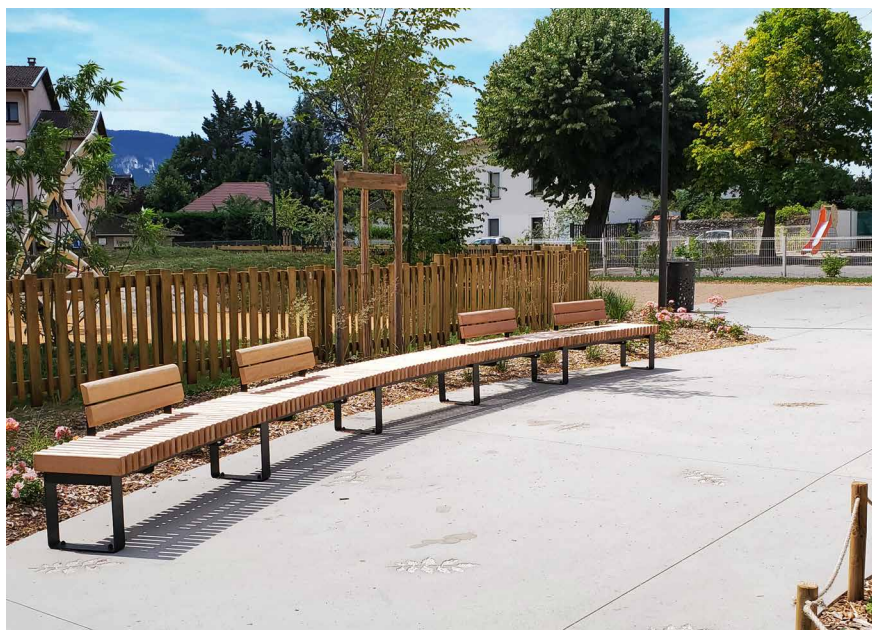

**Customized Affinité seat**  
Vinay - 38 - France

**Idylle half-tree surround**  
Pommiers - 69 - France

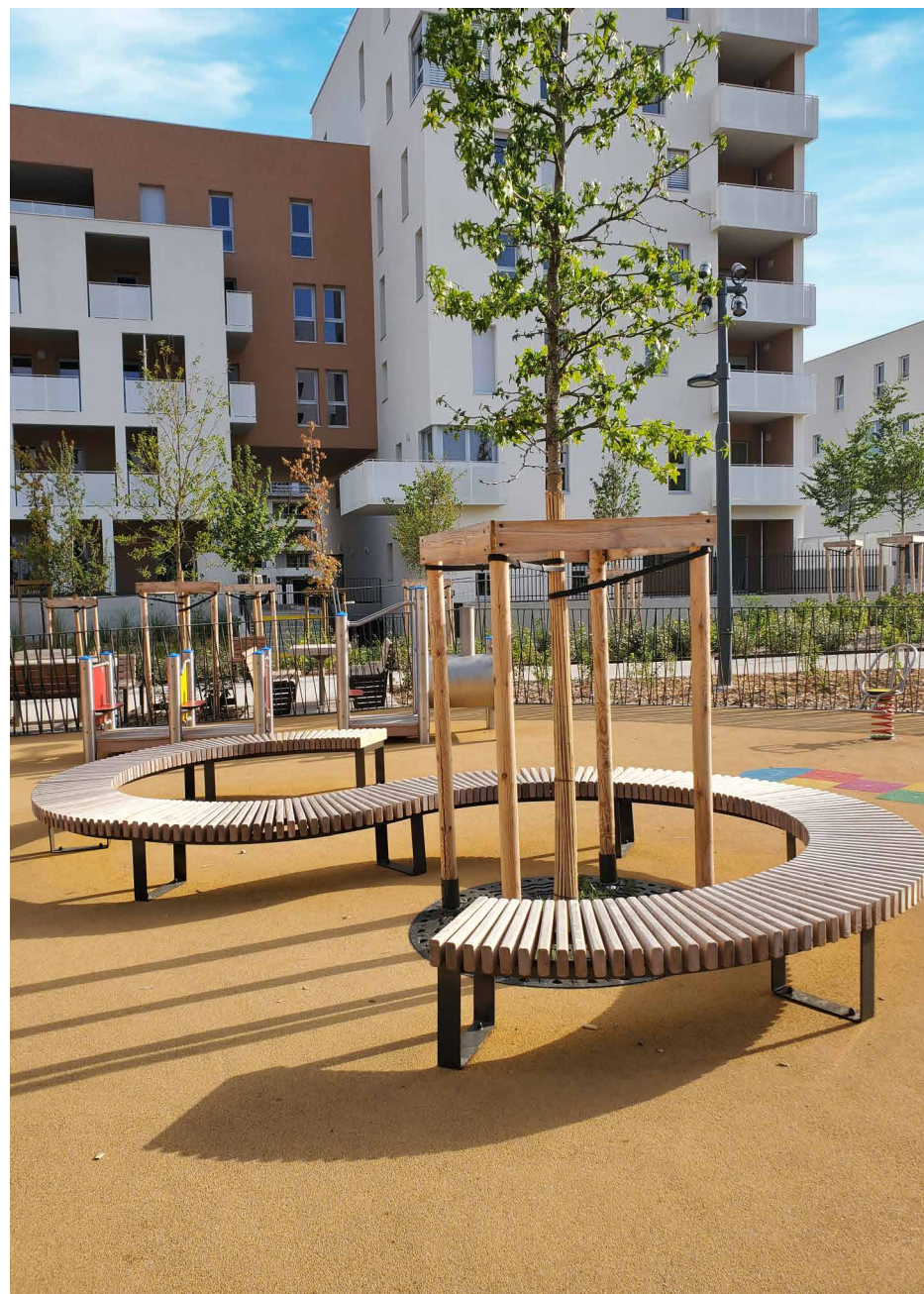

**Affinité furniture - Combination 6**  
Lyon - 69 - France

# Pétales

Design: Arturo ERBSMAN

**Materials:**

Exotic hardwood (without stain)  
Zinc and powder coated steel  
Fixing: to be buried or on base plates

LINE column  
street light

**selux**

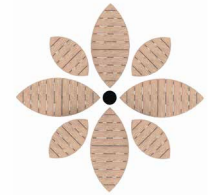

**Combination**  
**1 seat**  
**1 table**

Ref. 17 0500 000 001



**Combination**  
**1 seat**  
**1 curved table**

Ref. 17 0500 002

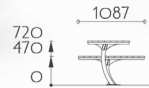

**Combination**  
**3 seats**

Ref. 17 0500 005



**Combination**  
**3 seats & 1 curved table**

Ref. 17 0500 010



**Combination**  
**3 seats & 2 tables**

Ref. 17 0500 006

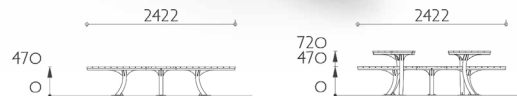

**360° combination**  
**4 seats & 4 tables**

Ref. 17 0500 007



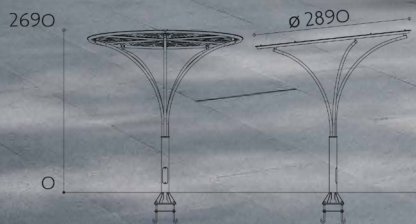

**Stem parasol**  
Leaf pattern  
Ref. 17 0901 OD10 AP00

# Tango City

**Design:** Cécile PLANCHAIS

**Materials:**

Zinc and powder coated steel  
HPL shelf

**NEW**

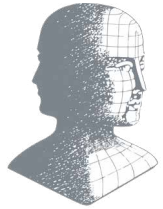

JANUS 2023  
DE LA CITÉ

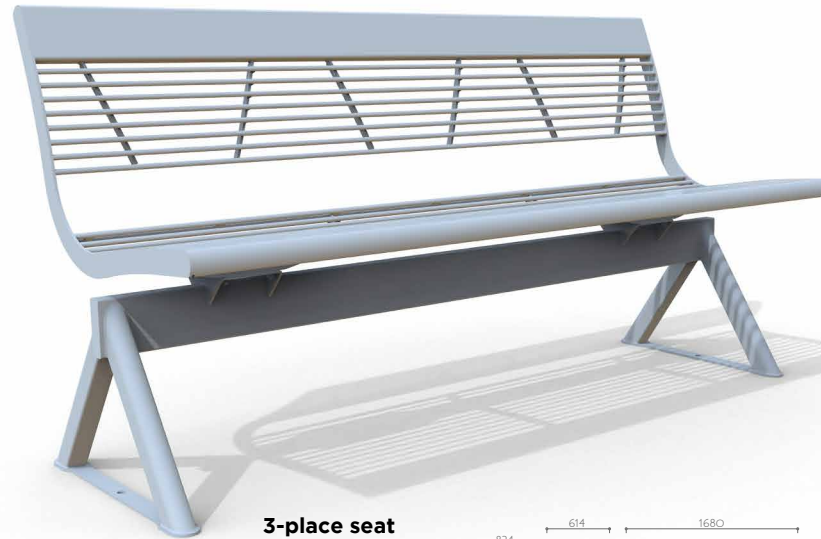

**3-place seat**  
Ref. 12 4430A

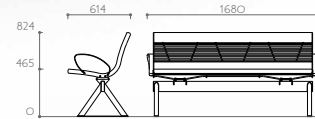

Available with  
armrests



Available with  
shelf



**Face-to-face Duo seats  
with 1 shelf and 2 armrests**  
Ref. 12 4421A-02

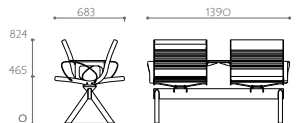

**Duo side-by-side seat  
with 2 shelves and 1 armrest**  
Ref. 12 4421A-01

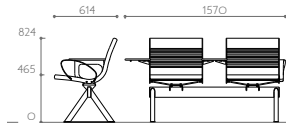

**Solo seat**  
Ref. 12 4410B

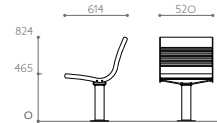

**4-place bench**  
Ref. 12 4445A



**3-place bench**  
Ref. 12 4435A

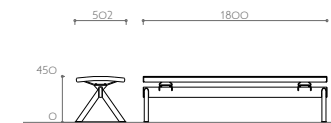



**Face-to-face Duo seats  
with 1 shelf and 2 armrests**  
Ref. 12 4421A-02

[www.sineugraff.com](http://www.sineugraff.com) - 95

**sineu  
graff**

# Tango Wood

**Design:** Cécile PLANCHAIS

**Materials:**

Stained ash or stained or unstained hardwood  
Zinc and powder coated steel  
HPL shelf

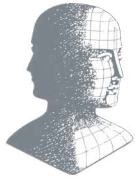

JANUS 2023  
DE LA CITÉ



**3-place seat**  
Ref. 12 4530A

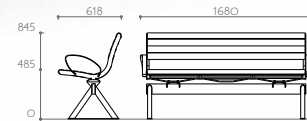

Available with  
armrests



Available with  
shelf



**Duo side-by-side  
with 2 shelves and 1 armrest**  
Ref. 12 4521A-01

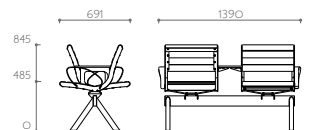

**Face-to-face Duo seats  
with 1 shelf and 2 armrests**  
Ref. 12 4521A-02

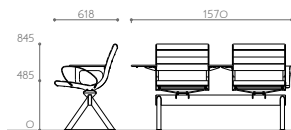

**Solo seat**  
Ref. 12 4510B

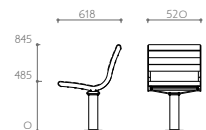

**4-place bench**  
Ref. 12 4545A

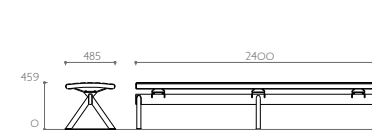

**3-place bench**  
Ref. 12 4535A

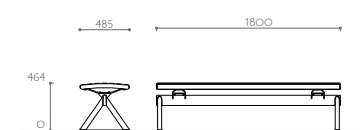

# Tango

**Design:** Cécile PLANCHAIS

**Materials:**  
Stained ash or stained or unstained hardwood  
Zinc and powder coated steel

**NEW**



**Picnic set**

Made up of:  
1 high table Ref. 12 4580  
6 solo seats Ref. 12 4510B

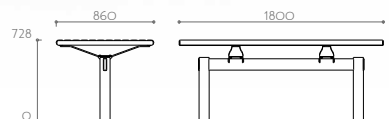

**Picnic set**

Made up of:  
1 high table Ref. 12 4480  
2 benches Ref. 12 4435B

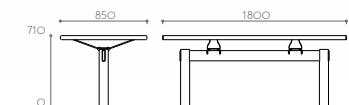

**Wooden lounge chair**  
Ref. 12 4570

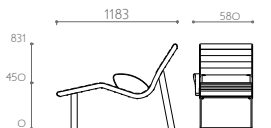

**2-place wooden lounger**  
Ref. 12 4575

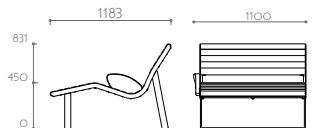

**Steel lounge chair**  
Ref. 12 4470

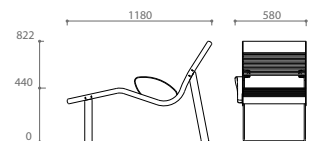

**2-place steel lounger**  
Ref. 12 4475

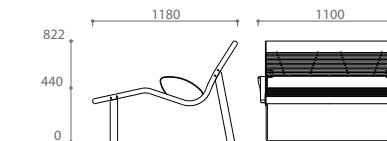

# Garden City

**Design:** Cécile PLANCHAIS

**Materials:**

Zinc and powder coated steel

Wood armrests: stained ash  
or stained or unstained hardwood



**3-place seat**  
Ref. 12 0230



**2-place seat**  
Ref. 12 0220



**Armchair**  
Ref. 12 0210



**3-place bench**  
Ref. 12 0270

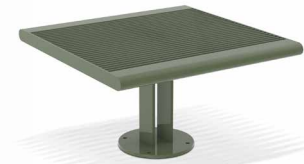

**Low table**  
Ref. 12 0240

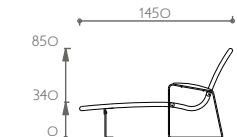
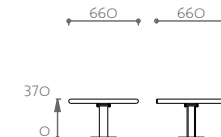
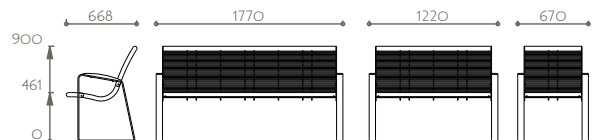

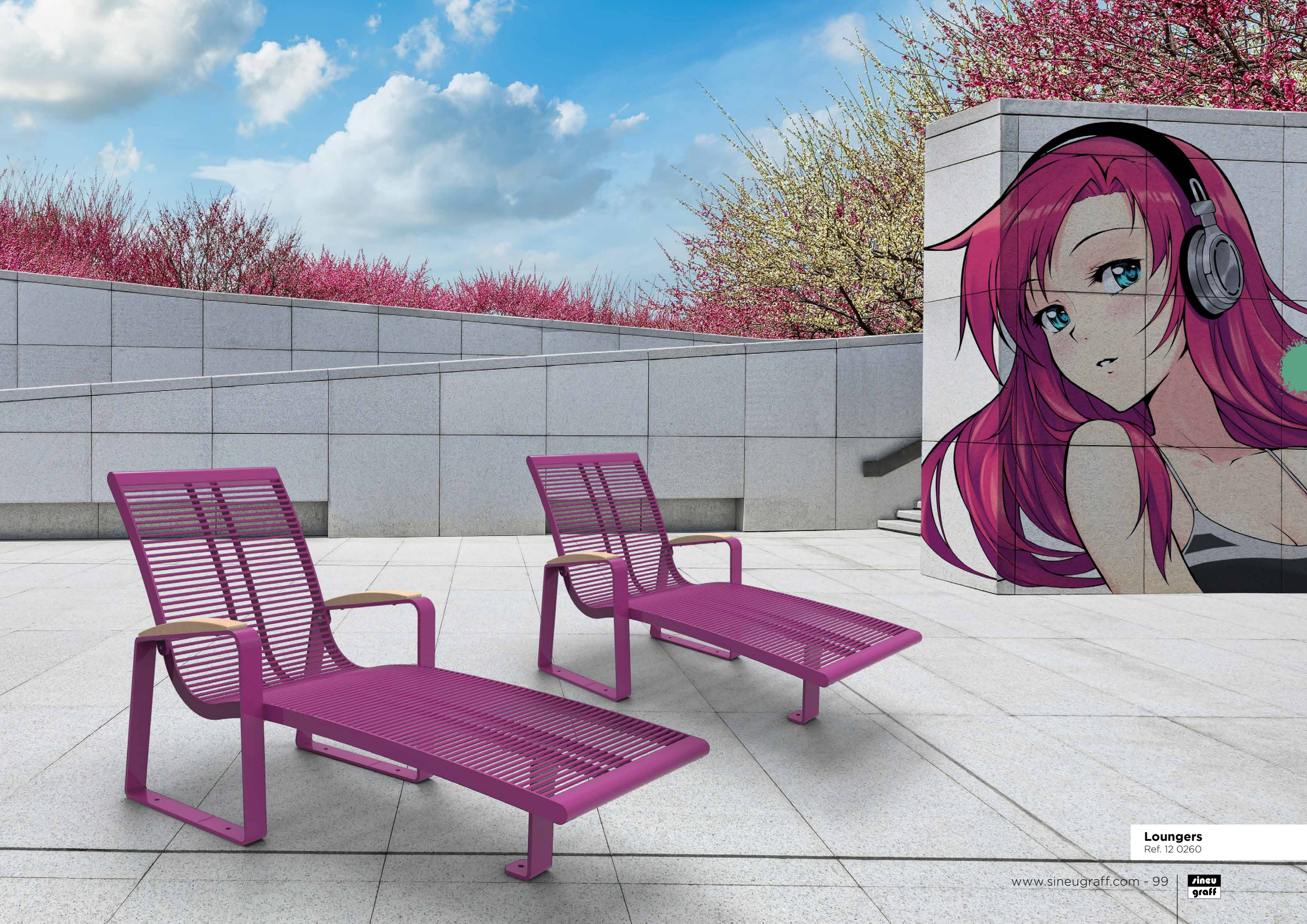

**Loungers**  
Ref. 12 0260

# Twist

**Design:** Fred TERRY - Agence STOA

**Materials:**

Stained ash or stained or unstained hardwood

Powder coated cast iron



**Available with armrests**



**3-place seat**  
Ref. 10 1030



**2-place seat**  
Ref. 10 1020



**Chair**  
Ref. 10 1010



**3-place bench**  
Ref. 10 1035



**2-place bench**  
Ref. 10 1025



**Stool**  
Ref. 10 1015

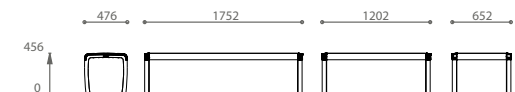
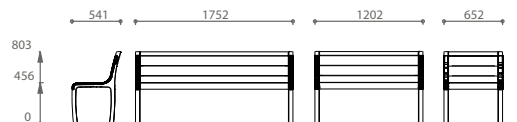

# Twist

**Design:** Fred TERRY - Agence STOA

**Materials:**  
Stained ash or stained or unstained hardwood  
Powder coated cast iron



## Curved 3-place bench

Inner diameter Ø 1.80 m  
External diameter Ø 1.90 m  
Ref. 10 1035C

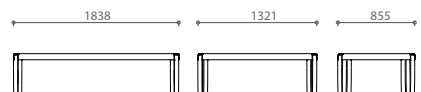

## Curved 2-place bench

Inner diameter Ø 8.50 m  
External diameter Ø 9.46 m  
Ref. 10 1025C



## Curved stool

Inner diameter Ø 2.50 m  
External diameter Ø 3.46 m  
Ref. 10 1015C



## Combination 1

Ref. 10 1030-TB-IN1010

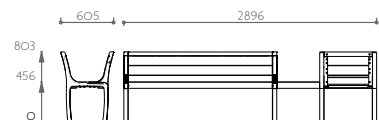

## Combination 2

Ref. 10 1010-TB-IN1010

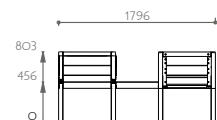

## Combination 3

Ref. 10 1035ACD-1020

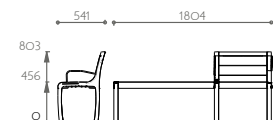

## Combination 4

Ref. 10 1025C-IN1015C-1025C

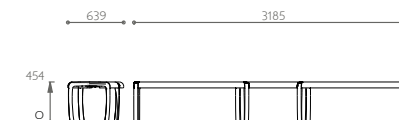

# Twist City

**Design:** Fred TERRY - Agence STOA

**Materials:**

Zinc and powder coated steel

Powder coated cast iron



Available with  
armrests



**3-place seat**  
Ref. 13 1030



**Chair**  
Ref. 13 1010



**2-place seat**  
Ref. 13 1020

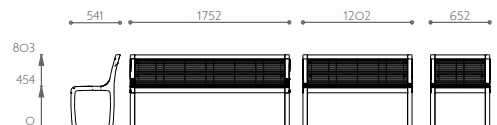

# Twist City

**Design:** Fred TERRY - Agence STOA

**Materials:**  
Zinc and powder coated steel  
Powder coated cast iron



**3-place bench**  
Ref. 13 1035



**2-place bench**  
Ref. 13 1025



**Stool**  
Ref. 13 1015



**Combination 1**  
Ref. 13 1030-TB-IN1010

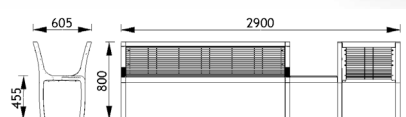

**Combination 2**  
Ref. 13 1010-TB-IN1010

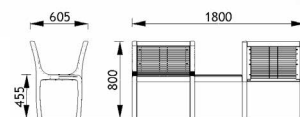

**Combination 3**  
Ref. 13 1025-G-1010 ACG

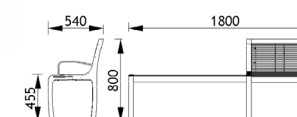



**Twist City armchairs and seats**  
Sartrouville - 78 - France

**Pétales sets**  
Arès - 33 - France



**Twist combination**  
Nice - 06 - France



**Twist furniture**  
Sangatte - 62 - France

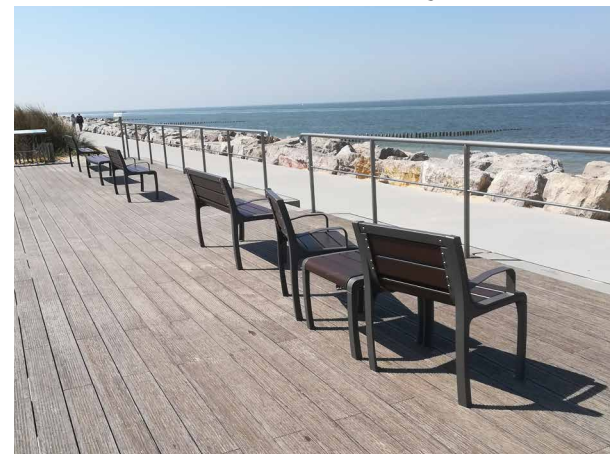



**Garden City set**  
Le Havre - 76 - France

**Garden City furniture**  
Boulogne-sur-Mer - 62 - France



**Garden City seat and litter bin**  
Villiers-sur-Marne - 94 - France

# Azur tab'

Design: Bernard ALTHABEGOÏTY

NEW



**3-place Azur Tab' bench**  
Ref. 10 2190

# Azur

**Design:** Philippe RIEHLING

**Materials:**

Stained ash or stained or unstained hardwood  
Zinc and powder coated steel  
PVC on request



**Available with  
armrests**



**3-place seat**  
Ref. 10 0190



**2-place seat**  
Ref. 10 0191



**Chair**  
Ref. 10 0192

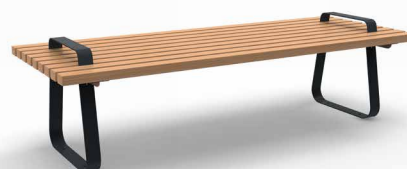

**Wide bench**  
Ref. 10 0196

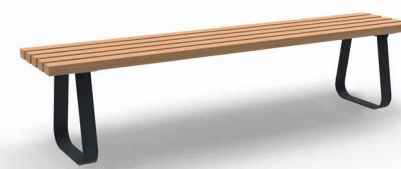

**Narrow bench**  
Ref. 10 0195

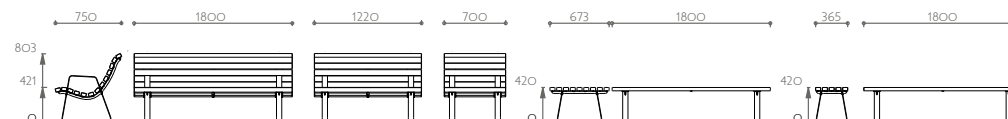
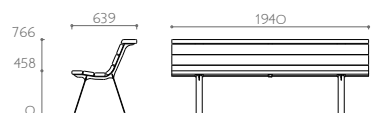

# Conversation

**Design:** Bernard ALTHABEGOÏTY

**Materials:**

Stained ash or stained or unstained hardwood

Powder coated cast iron



**3-place high seat**  
Ref. 10 0060



**Lounger**  
Ref. 10 0068



**3-place wide bench**  
Ref. 10 0065



**3-place narrow bench**  
Ref. 10 0066

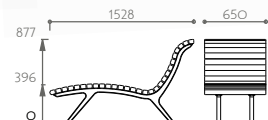
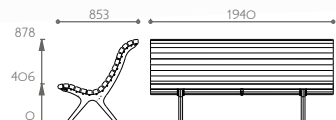

# Conversation tablette

**Design:** Bernard ALTHABEGOÏTY

**Materials:**

Stained ash or stained or unstained hardwood  
Powder coated cast iron



**3-place bench  
Conversation with shelf**  
Ref. 10 0070



**Continuous configuration**

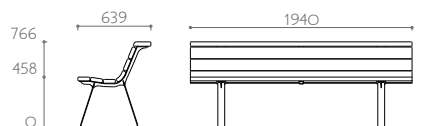

# Confort

**Design:** Sineu Graff

**Materials:**

Stained ash, stained or unstained hardwood  
Powder coated cast iron



**3-place seat Confort 1**  
Ref. 10 0002



**3-place seat Confort 2**  
Ref. 10 0003

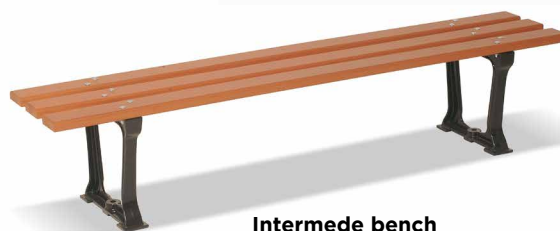

**Intermede bench**  
Ref. 10 0009

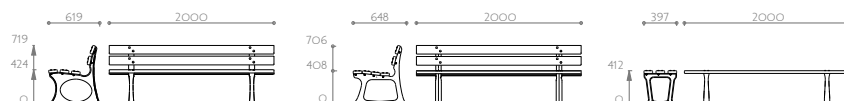



**3-place seat Confort 2**  
Ref. 10 0003

[www.sineugraff.com](http://www.sineugraff.com) - 111



# Confort

## Recycled Reinforced Plastic

**Design:** Sineu Graff

**Materials:**

Recycled Reinforced Plastic

Powder coated cast iron



**3-place seat Confort 1**  
Ref. 10 0002 PM1B OP00



**3-place seat Confort 2**  
Ref. 10 0003 PM1S OP00



**Intermede bench**  
Ref. 10 0009 PM1G OP00

**Available colours**

- Brown 
- Green 
- Sand 
- Grey 
- Black 

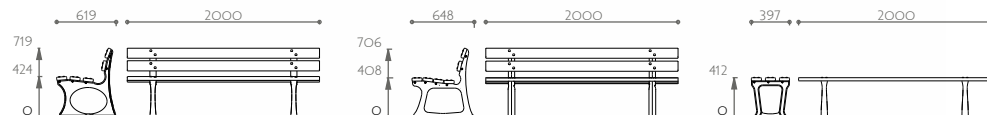

# Confort City

**Design:** Sineu Graff

**Materials:**

Zinc and powder coated city steel or laser cut

Powder coated cast iron



**3-place seat Confort 2 - Saint Denis**  
Ref. 13 004



**3-place seat Confort 1 - Citadelle**  
Ref. 13 0005



**3-place bench Citadelle**  
Ref. 13 0005B



**3-place seat Confort 2 - Nature pattern**  
Ref. 13 1003



**3-place seat Confort 1 - Nature pattern**  
Ref. 13 1013

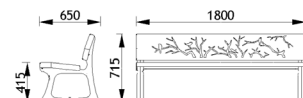
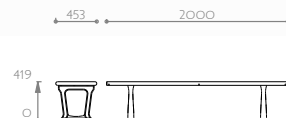
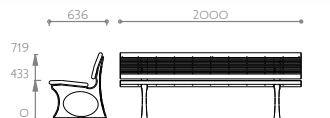

# Confort Evolution

**Design:** Sineu Graff

**Materials:**

Stained ash or stained or unstained exotic wood  
Powder coated cast iron



**Available with  
armrests**



**3-place seat**  
Ref. 10 2033



**2-place seat**  
Ref. 10 2023



**Chair**  
Ref. 10 2013

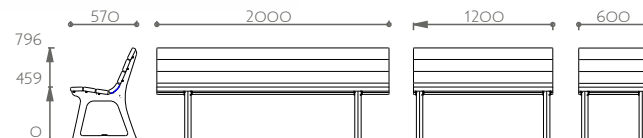



Available with  
armrests

# Confort Evolution City

**Design:** Sineu Graff

**Materials:**

Zinc and powder coated city steel  
Powder coated cast iron



**3-place seat**  
Ref. 13 2033



**2-place seat**  
Ref. 13 2023



**Chair**  
Ref. 13 2013

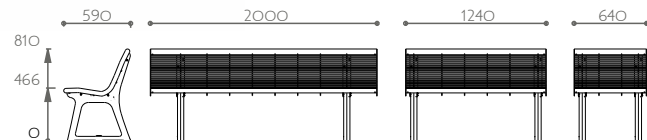

# Confort Evolution Recycled Reinforced Plastic

**Design:** Sineu Graff

**Materials:**

Recycled Reinforced Plastic  
Powder coated cast iron



**Available with  
armrests**



**3-place seat**  
Ref. 10 2033 PM1N OP00



**2-place seat**  
Ref. 10 2023 PM1S OP00



**Chair**  
Ref. 10 2013 PM1G OP00

**Available colours**

- Brown
- Green
- Sand
- Grey
- Black

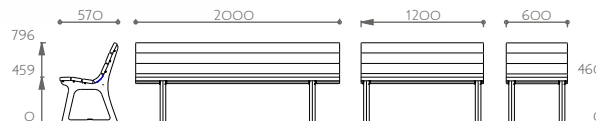

# Centaure

**Design:** Sineu Graff

**Materials:**

Stained ash, stained or unstained hardwood  
Powder coated cast iron



**Centaure Evolution 3-place seat**  
Ref. 10 0100



**Royal 3-place seat**  
Ref. 10 0050



**Expression 3-place seat**  
Ref. 10 0310

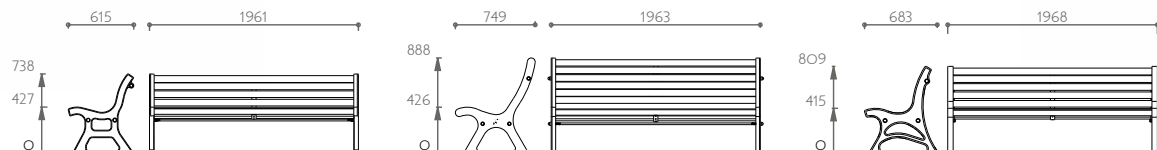

# Centaure

## Recycled Reinforced Plastic

**Design:** Sineu Graff

**Materials:**

Recycled Reinforced Plastic  
Powder coated cast iron

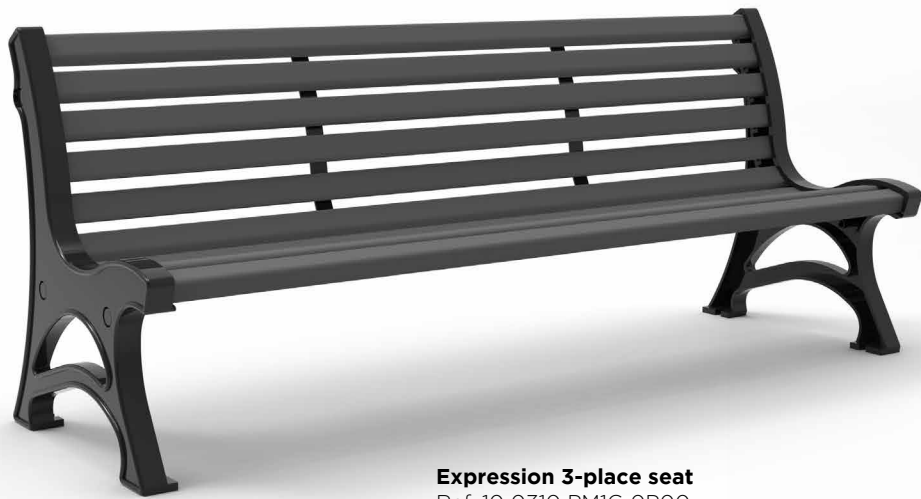

**Expression 3-place seat**  
Ref. 10 0310 PM1G 0P00

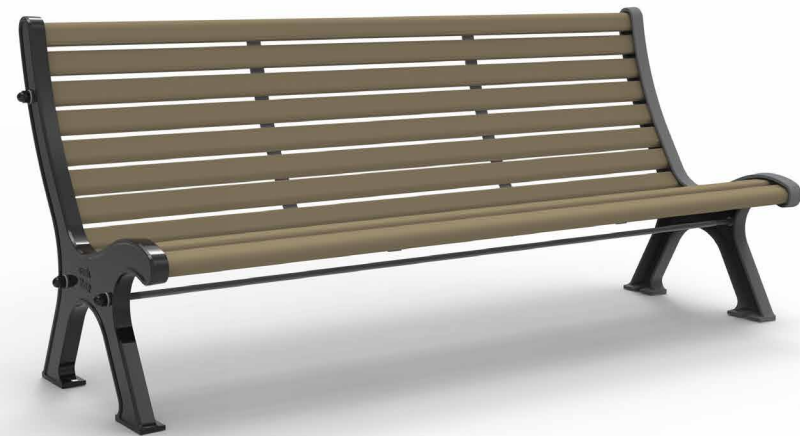

**Royal 3-place seat**  
Ref. 10 0050 PMIS 0P00

**Available colours**

- Brown 
- Green 
- Sand 
- Grey 
- Black 

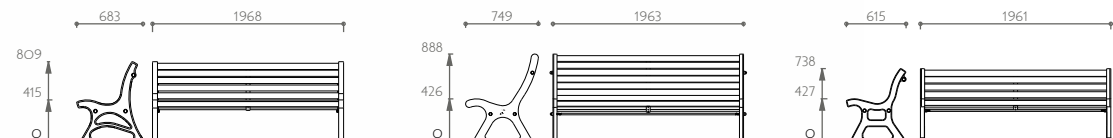



PREFER  
THE  
ORIGINAL

**Centaure Evolution**  
Ref. 10 0100 PM1B OP00

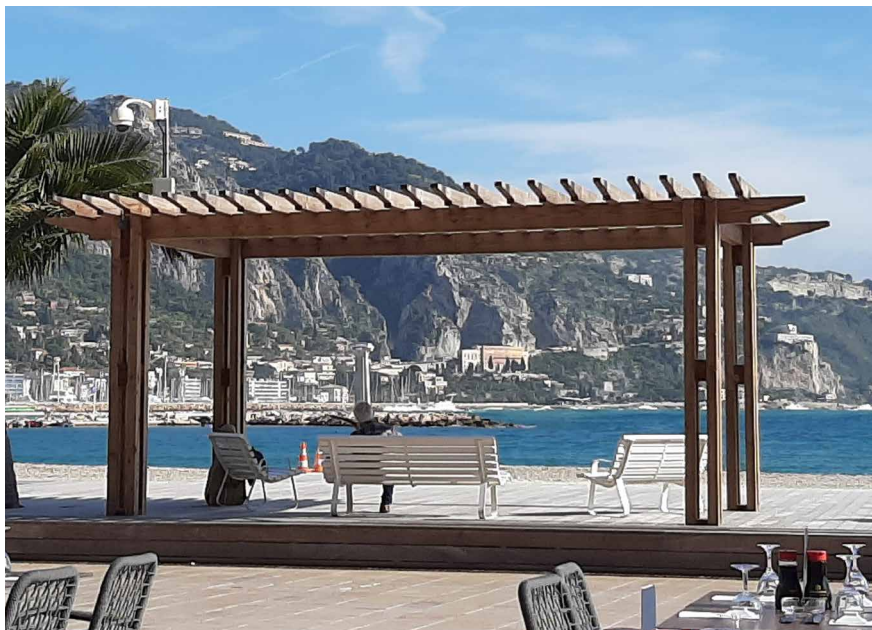

**Azure seats**  
Menton - 06 - France

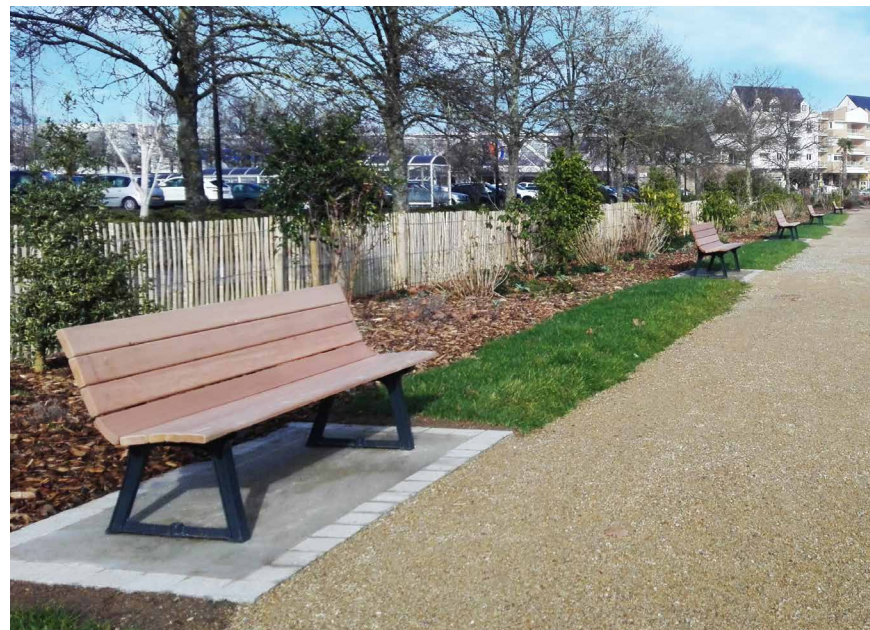

**Confort Evolution seats**  
Lanester - 56 - France

**RRP Confort Evolution seats**  
Temporary installation

**Confort 2 Nature seat**  
Bourbourg - 59 - France





**Centaure Evolution seat**  
Den Helder - The Netherlands

**Conversation seats**  
Bourg-les-Valence - 26 - France

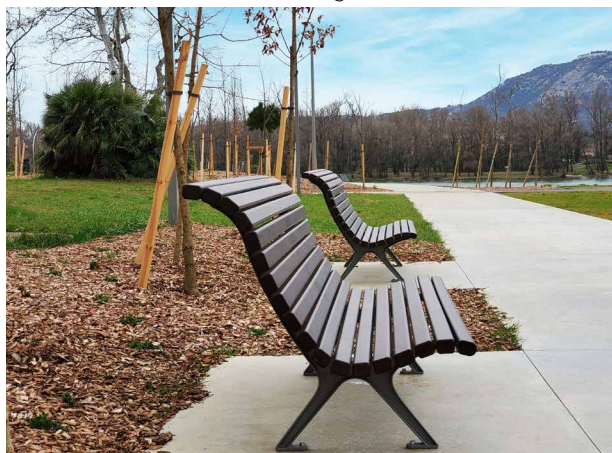

**Conversation loungers**  
Lormont - 33 - France

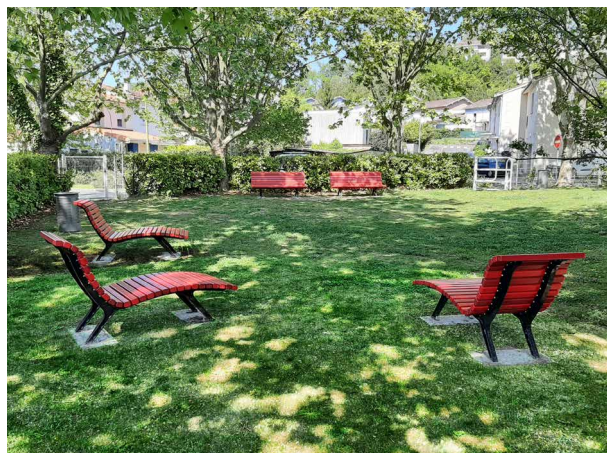

**Confort Evolution chairs**  
Nice - 06 - France



# Optima

**Design:** Cécile PLANCHAIS

**Materials:**

Stained ash or  
stained or unstained hardwood  
Zinc and powder coated steel



Available with  
armrests

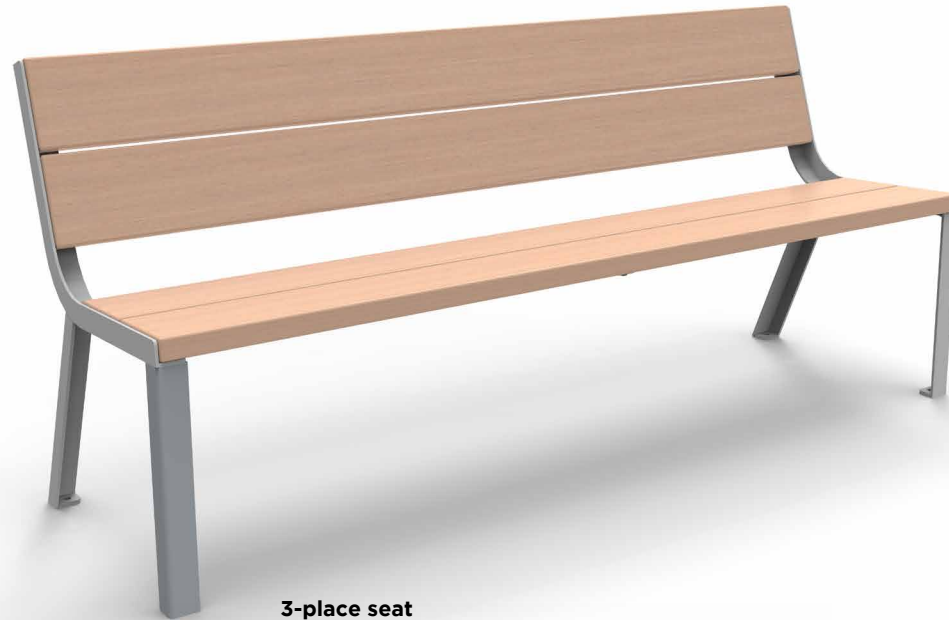

**3-place seat**  
Ref. 10 3030



**2-place seat**  
Ref. 10 3020



**Chair**  
Ref. 10 3010



**3-place bench**  
Ref. 10 3060



**Low table**  
Ref. 10 3070



**High table**  
Ref. 10 3080

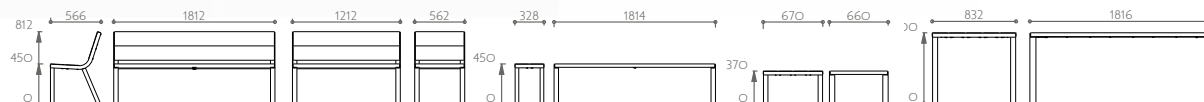

# Opticar

**Design:** Cécile PLANCHAIS

**Materials:**

Stained ash  
or stained or unstained hardwood  
Zinc and powder coated steel



Available with  
armrests

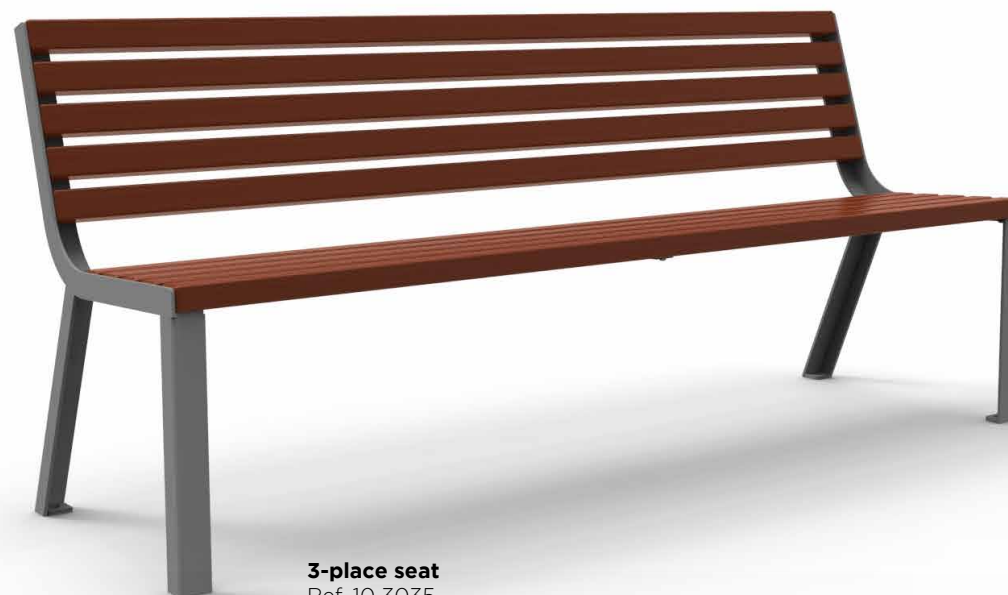

**3-place seat**  
Ref. 10 3035



**2-place seat**  
Ref. 10 3025



**Chair**  
Ref. 10 3015



**3-place bench**  
Ref. 10 3065

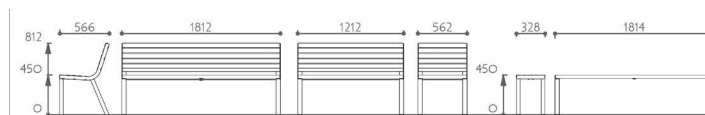

# Optima City

**Design:** Cécile PLANCHAIS

**Materials:**

Zinc and powder coated steel

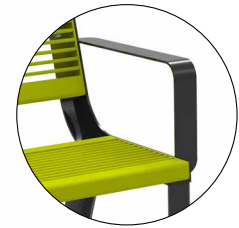

Available with  
armrests

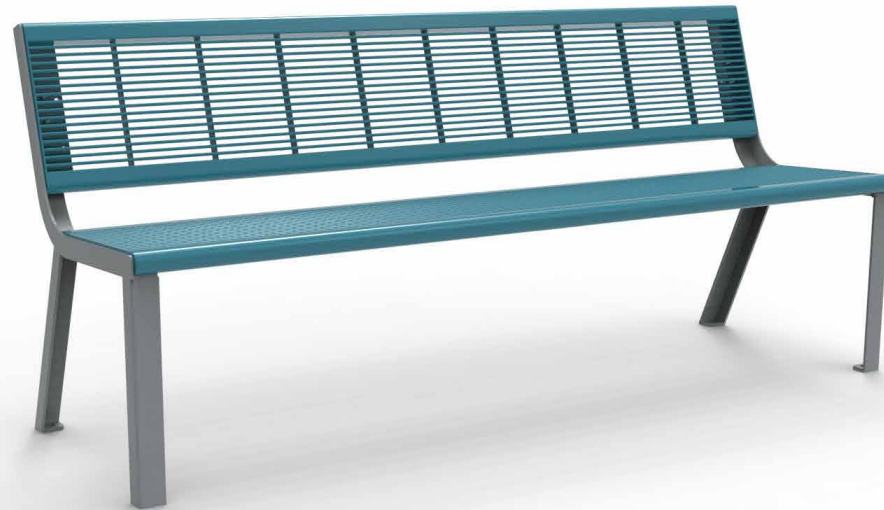

**3-place seat**  
Ref. 13 3030 CITY



**2-place seat**  
Ref. 13 3020 CITY



**Chair**  
Ref. 13 3010 CITY



**3-place bench**  
Ref. 13 3060 CITY



**Low table**  
Ref. 13 3070 CITY



**High table**  
Ref. 13 3080 CITY

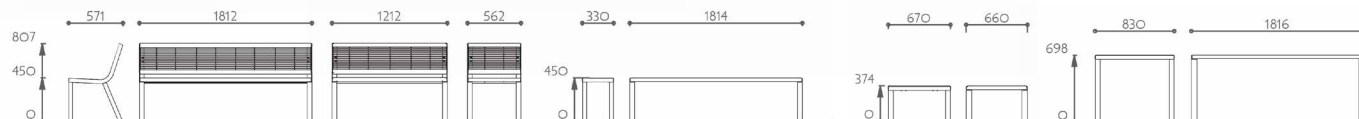



Available with armrests

# Optima laser cut

**Design:** Sineu Graff

**Materials:**  
Zinc and powder coated steel



**Nature 3-place seat**  
Ref. 13 3030 NAT

**Standard available patterns**

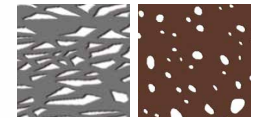

Graphic Pebbles

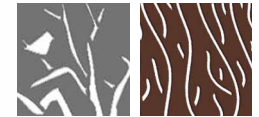

Nature Roots



Jazz



**2-place pebbles seat**  
Ref. 13 3020 RAC



**Nature chair**  
Ref. 13 3010 NAT

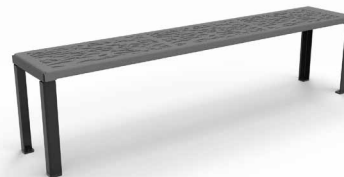

**Graphic 3-place bench**  
Ref. 10 3060 GRA



**Jazz low table**  
Ref. 13 3070



**Nature high table**  
Ref. 13 3080 NAT



# Zénith

**Design:** Emmanuel ROULET

**Materials:**

Stained ash or stained or unstained wood  
Powder coated cast iron



**3-place seat**  
Ref. 10 0630



**Chair**  
Ref. 10 0610



**2-place seat**  
Ref. 10 0620



**Low table**  
Ref. 10 0640  
Legs in zinc and powder coated steel

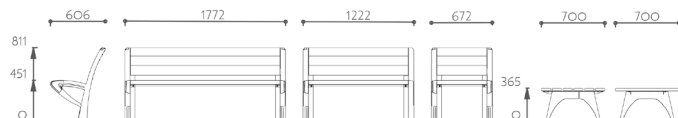

# Zénith City

**Design:** Emmanuel ROULET

**Materials:**

Zinc and powder coated steel  
Powder coated cast iron



**3-place seat**  
Ref. 13 0630



**Chair**  
Ref. 13 0610



**2-place seat**  
Ref. 13 0620



**Low table**  
Ref. 13 0640  
Legs in zinc and powder coated steel

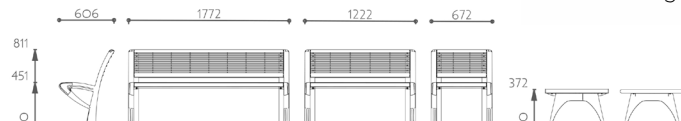

# Rendez-vous

**Design:** Emmanuel ROULET

**Materials:**

Stained ash or stained or unstained wood  
Powder coated cast iron



**3-place seat**  
Ref. 10 0200



**3-place curved bench**  
Inner diameter Ø 2.12 m  
External diameter Ø 2.99 m  
Ref. 10 0205C

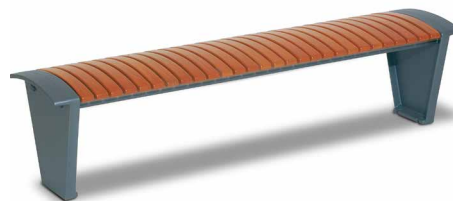

**3-place bench**  
Ref. 10 0205



**High table**  
Ref. 10 0425 LATTES  
Legs in zinc and powder coated steel

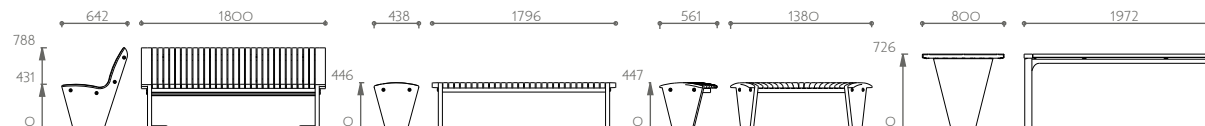

# Rendez-vous City

**Design:** Emmanuel ROULET

**Materials:**

Zinc and powder coated steel  
Powder coated cast iron

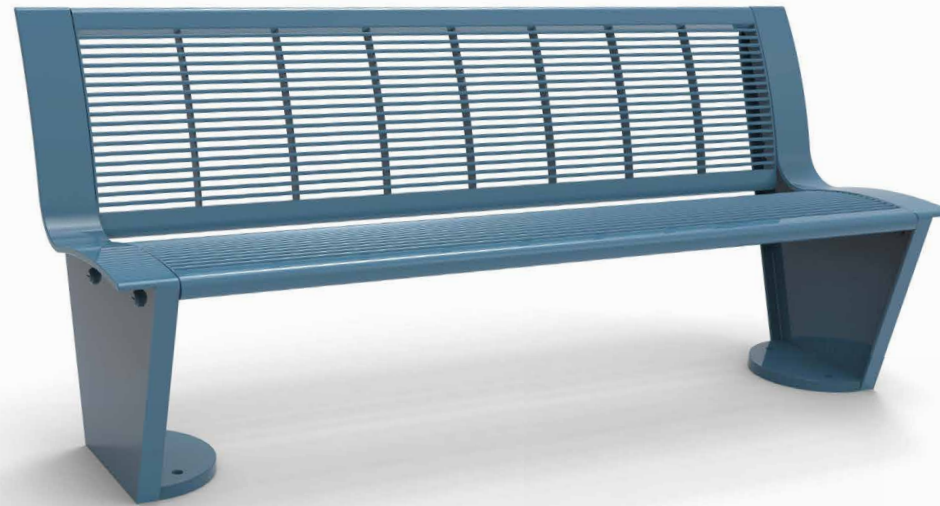

**3-place seat**  
Ref. 13 0200

Examples of combinations

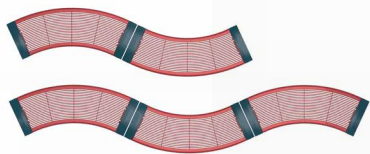

**3-place curved bench**  
Inner diameter Ø 2.20 m  
External diameter Ø 3.07 m  
Ref. 13 0205C

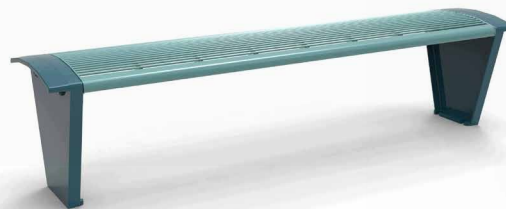

**3-place bench**  
Ref. 13 0205



**High table**  
Ref. 13 0425  
Legs in zinc and powder coated steel

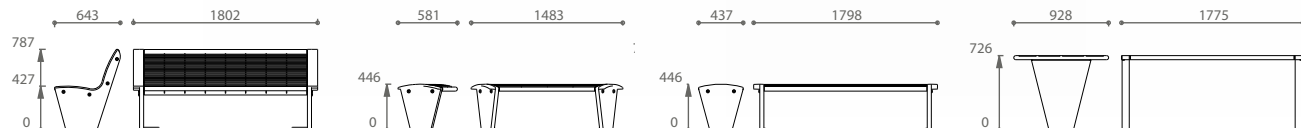

# Metropolis

**Design:** Emmanuel ROULET

**Materials:**

Stained ash or stained or unstained hardwood  
Powder coated cast iron



**3-place seat**  
Ref. 10 0210



**3-place bench**  
Ref. 10 0215



**High table**  
Ref. 10 0425 LATTES  
Legs in zinc and powder coated steel



# Opéra

**Design:** Sineu Graff

**Materials:**

Stained ash or stained or unstained hardwood

Powder coated cast iron



**3-place seat**  
Ref. 10 298400



**2-place seat**  
Ref. 10 298402



**Chair**  
Ref. 10 298405



**Low table**  
Ref. 10 0640

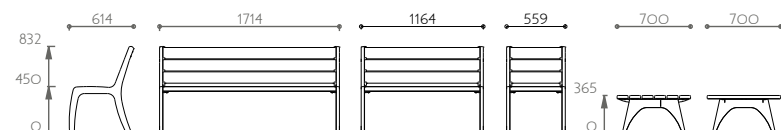



**3-place seat**  
Ref. 10 0802

# Victoria

**Design:** Sineu Graff

**Material:**  
Stained or unstained hardwood



**3-place seat**  
Ref. 10 0802



**Armchair**  
Ref. 10 0804



**3-place bench**  
Ref. 10 0806



**Low table**  
Ref. 10 0805



**High table**  
Ref. 10 0803





**Optima seats**  
Cambridgeshire - United Kingdom

**Opera chairs**  
Amsterdam - The Netherlands

**Graphic Optima chairs**  
Meaux - 77 - France

**Opticar seats and chairs**  
Carquefou - 44 - France

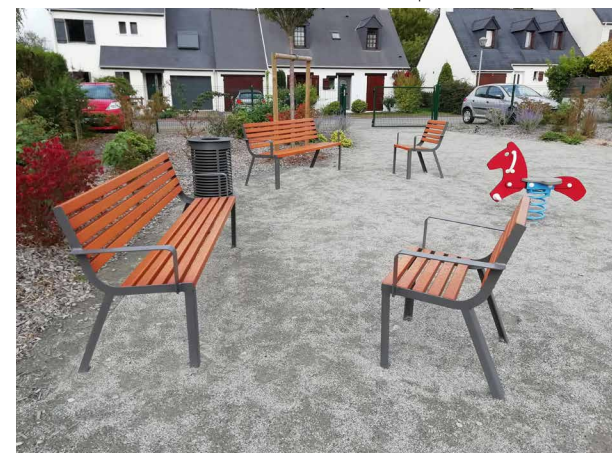
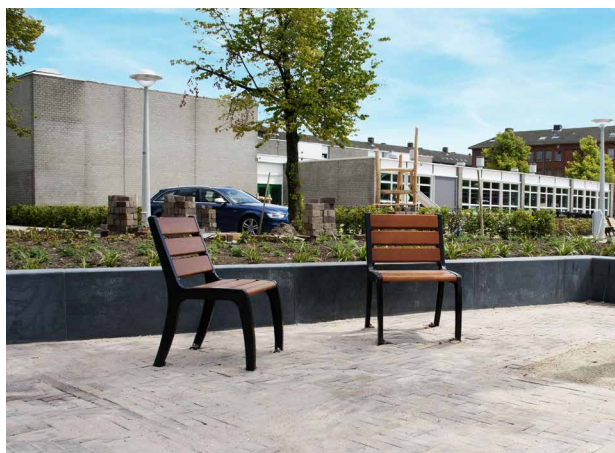



**Victoria seats**  
Lisses - 91 - France

**Rendez-vous seats**  
Marcq-en-Baroeul - 59 - France



**Optima seats**  
Moirans - 38 - France



**Victoria seat**  
Vitrolles - 13 - France

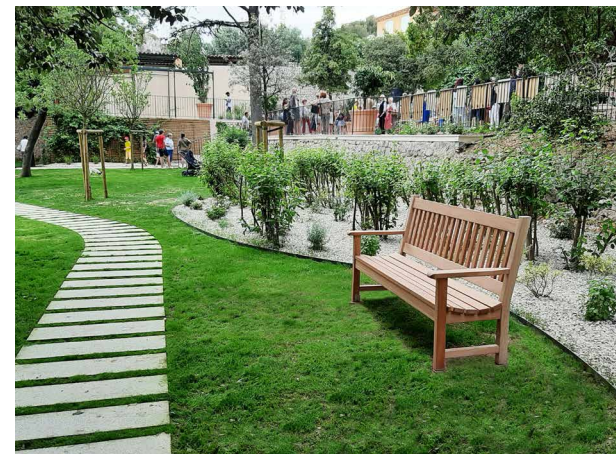

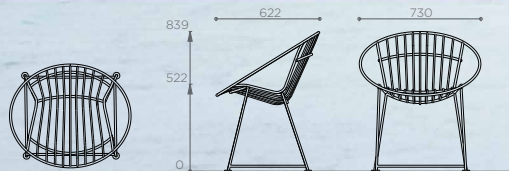

# Aliou

**Design:** Sineu Graff

**Material:**

Varnished rebar

Fixing: on base plates or to be buried

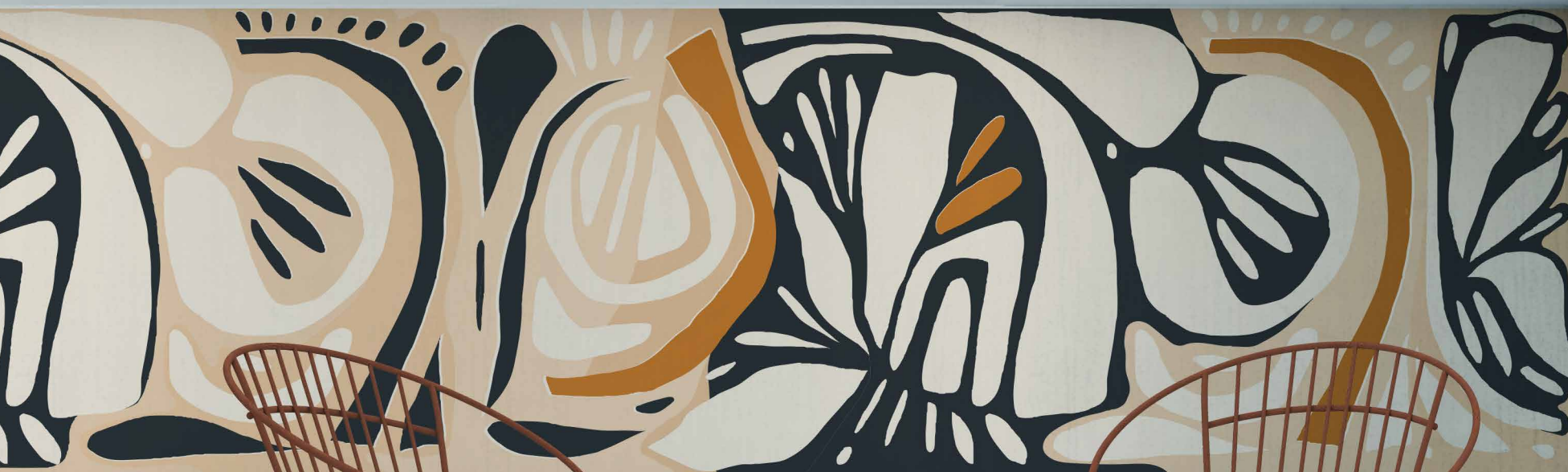

**Aliou armchair**  
Ref. 13 6015

[www.sineugraff.com](http://www.sineugraff.com) - 137







# Rubber Line

Design: Clément WILLEMEN



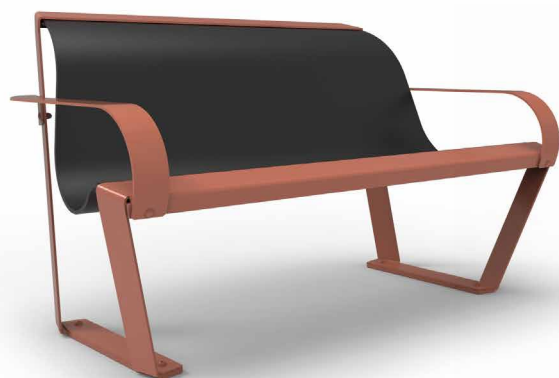

**2-place seat  
with armrests**  
Ref. 10 4125



**Table**  
Ref. 10 4070



**High armchair**  
Ref. 10 4115

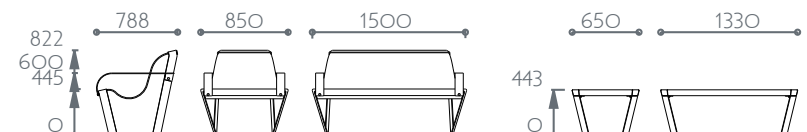

# Rubber Line

**Design:** Clément WILLEMIN

**Materials:**  
Zinc and powder coated steel  
Reinforced rubber



**Low chair**  
Ref. 10 4010

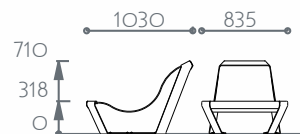



# Live

**Design:** Fred TERRY - Agence STOA





**4-seat table**  
Ref. 15 1240  
Optional "Ludo" game board



**2x Table 2 seats**  
Ref. 15 1220  
Optional "Noughts and Crosses" game board

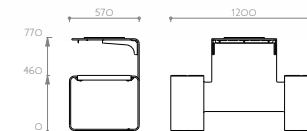

# Live

**Design:** Fred TERRY - Agence STOA

**Materials:**

Zinc and powder coated steel  
Stained ash, stained or unstained hardwood  
HPL game boards



**High table**  
Ref. 15 1300



**2-seat table**  
Ref. 15 1220  
Optional "Chess" game board

**High stool**  
Ref. 15 1150

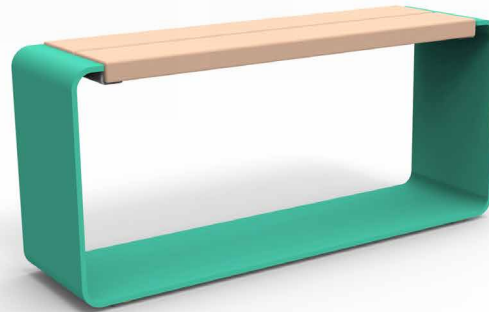

**2-place bench**  
Ref. 15 1120

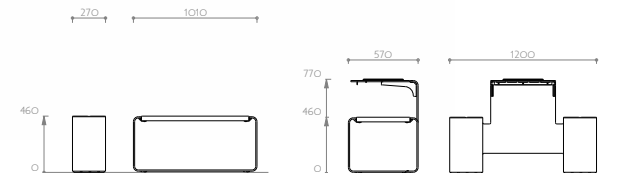
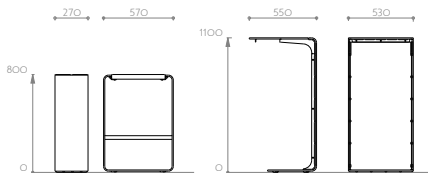



**Aliou armchairs**  
Metz - 57 - France



**Live table with chessboard**  
Hasselt - Belgium



**Live tables with seats**  
Sartrouville - 78 - France

**Rubber chairs and table**  
Clermont Ferrand - 63 - France

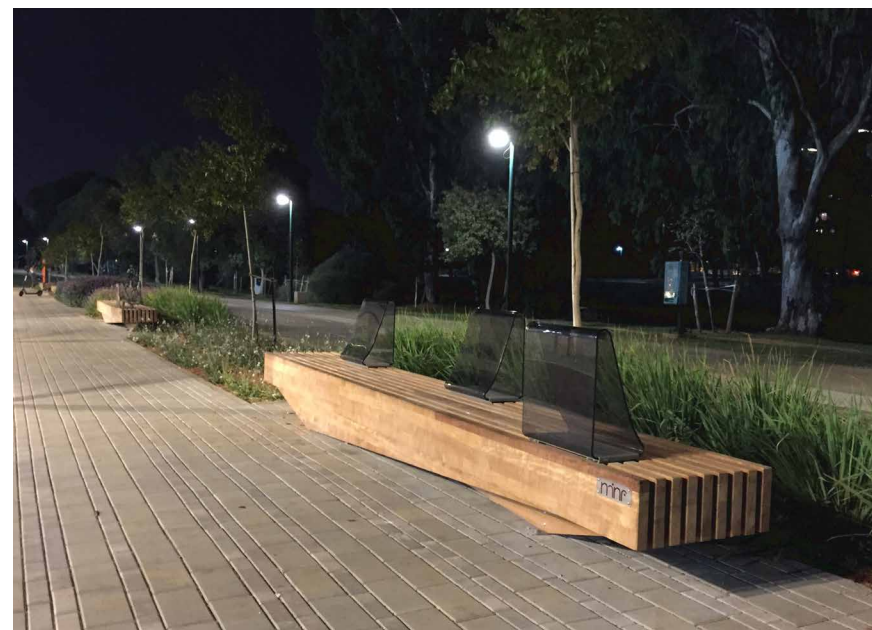

**Nine bench**  
Tel Aviv - Israel

**Nine bench**  
Dunkerque - 59 - France

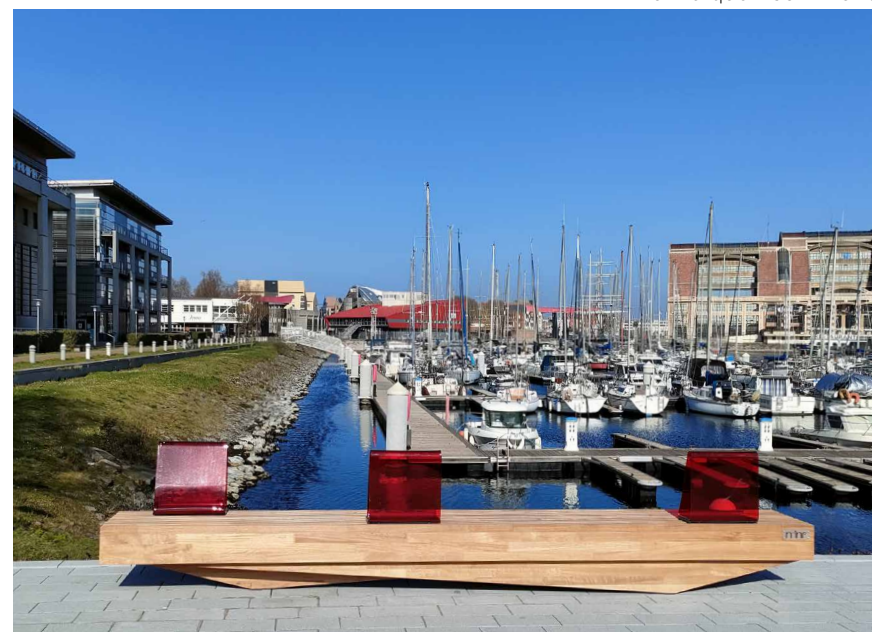

# Green city

## Experience nature differently

The greenery in town, a delightful treasure, justifies its lush presence. Flowers and plants, a symphony of colour, offer city dwellers a myriad of benefits. They brighten up the cityscape, variations of soothing sizes, standing out from the stern facades. Plant evapotranspiration cools cities and amplifies soil permeability. Insects and birds find refuge in this haven of life. Above-ground floral structures, like earth's reservoirs, charm enthusiasts and reconnect us with our essence. By capturing CO<sub>2</sub> and lowering the temperature, urban flower beds, an engraved instinct, connect us to the earth. Our essence, our inner greenness, aspires to tread the earth in the city that surrounds us.





**Steel Garden**



# An innovative solution to save water!

# Sineu Flor®



## The clay ball, a material that's:

**Ecological:** it's natural, sustainable and recyclable.

**Draining:** an 8/16 calibrated ball, which allows for 45% empty space between the balls for better aeration of the roots.

**Hydro-retentive:** retains rain or irrigation water.

**Hygro-retentive:** captures and restores humidity.

**Rot-proof:** technical and chemical durability.

**Incombustible:** possibility of operation inside buildings.

**Microporous:** fills with water without increasing in volume.

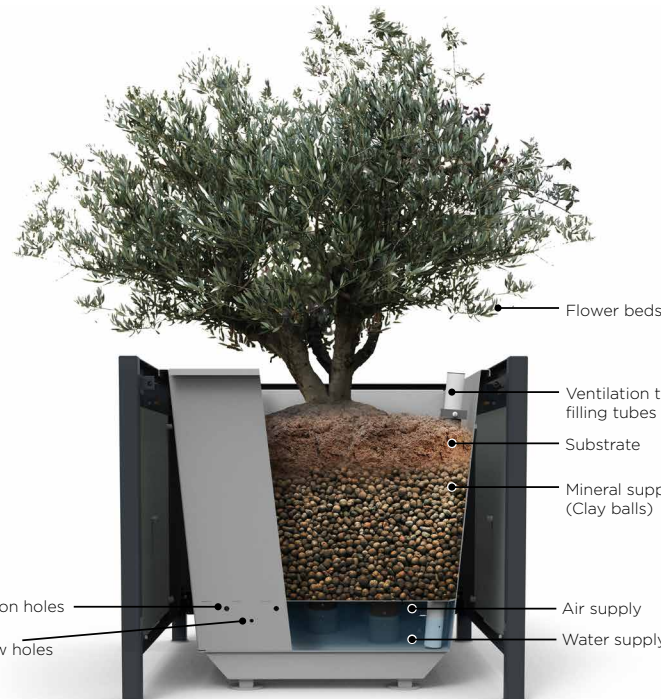

**Sineu Flor® is a patented solution that will help you save water and associated resources while optimising above-ground vegetation.**

Sineu Graff developed this patent to address an issue we encounter every day with our Customizeders.

**Developing high-quality street planting in cities** inexorably increases the consumption of water resources, time and labour.

However, this growing consumption of resources is not compatible with environmental objectives, budgetary requirements and increasingly limited resources.

Sineu Flor® is the solution that will let you continue flowering your city and enhancing your living environment. This patented innovation reduces both water consumption and watering frequency, while improving the quality of flowering.

## 1 Reducing water consumption

Sineu Flor® consists of a technical tank, a mineral support (the clay ball) and an enriched substrate.

The clay ball captures water (watering water, ambient humidity, condensation, etc.), stores and releases it: it means the plant can absorb water by osmosis.

The plant thus has a double water reserve: what's stored in the tray, and what's stored in the clay ball.

## 2 Reducing resource consumption

Reducing the watering frequency will free up some of the human resources dedicated to the task. Workers can then be redeployed to other tasks, which reduces the overall cost of flowering.

Example: City of Tomorrow - 60 hours of labour saved over a flowering season on 7 equipped Sineu Flor® planters.

## 3 Reducing greenhouse gases

In the case of manual watering, reducing the frequency of watering limits the frequency of vehicle visits, and therefore the release of greenhouse gases.

## 4 A universal solution

The Sineu Flor® system is suitable for all planters in the Sineu Graff street planting programme, including flower benches and mobile gardens.

**We also offer a bespoke service, with the option of adapting our patent to existing planters.**

# Steel Garden

**Design:** Sineu Graff

**Materials:**

Corten®-type untreated steel or with accelerated rusting treatment + protective varnish and stabilisation option  
Hardwood seating

The shapes are made to measure to adapt to each layout.  
Seating is possible continuously or intermittently.

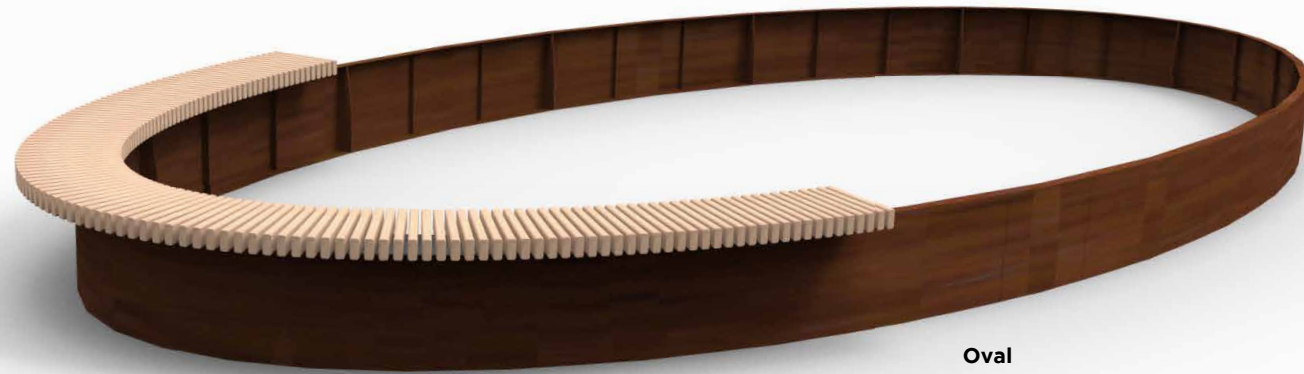

Oval

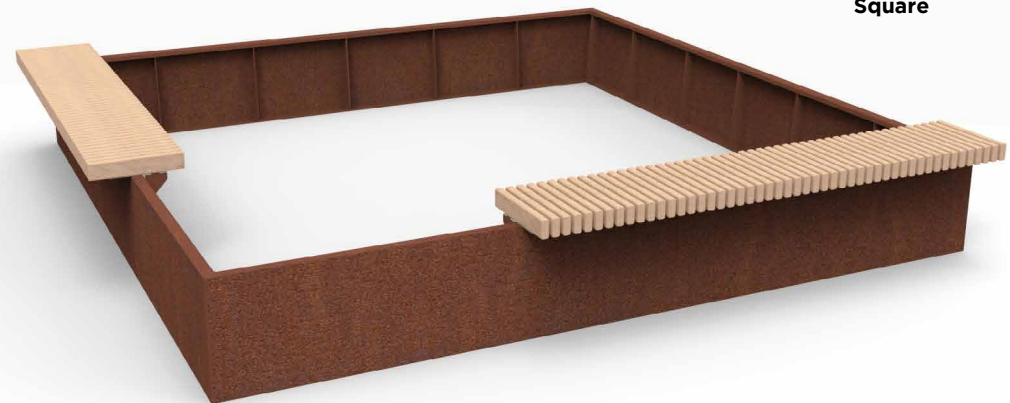

Square

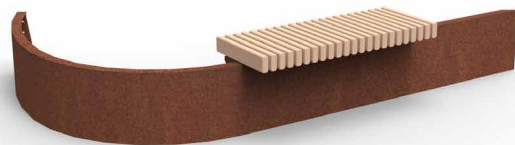

Half-drop



# Steel Garden

**Design:** Sineu Graff

**Materials**

Corten®-type untreated steel or with accelerated rusting treatment + protective varnish and stabilisation option  
Hardwood seating

The shapes are made to measure to adapt to each layout.  
Seating is possible continuously or intermittently.

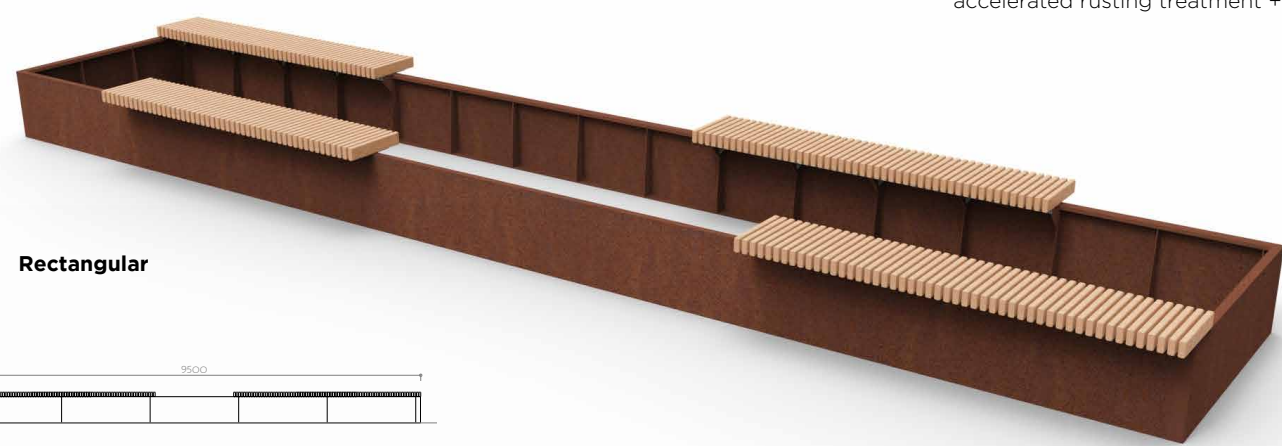

**Rectangular**

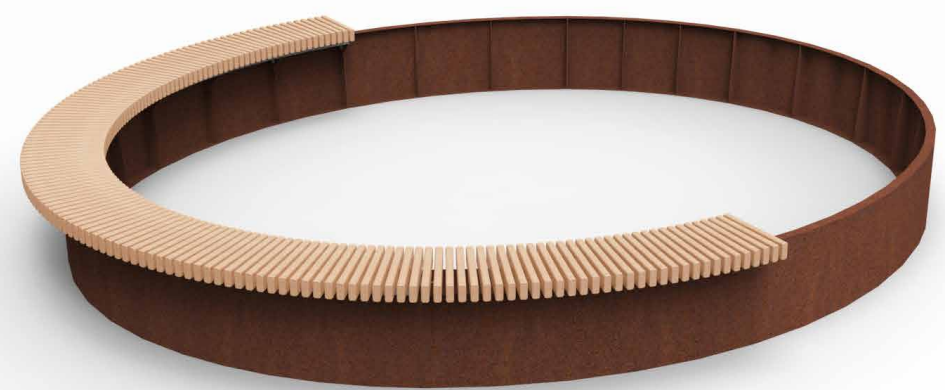

**Round**

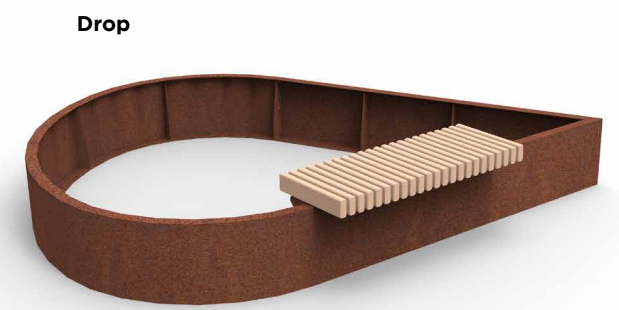
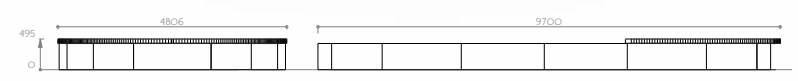

**Drop**

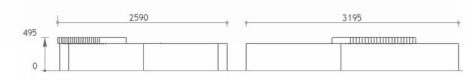

# Mobile Gardens

**Design:** Cécile PLANCHAIS

**Materials:**

Peripheral seating: raw or stained exotic wood

Cladding: Zinc and powder coated steel

Growing tubs: Galvanised steel

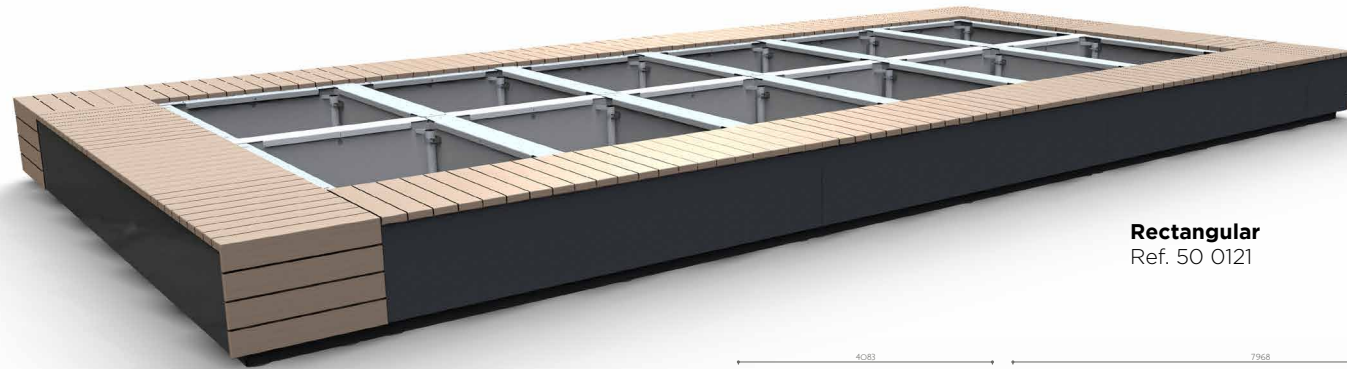

**Rectangular**

Ref. 50 0121

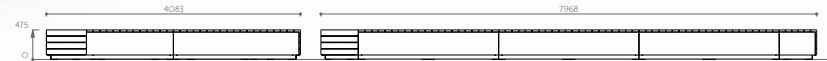

**Square mobile forest**

Ref. 50 1101

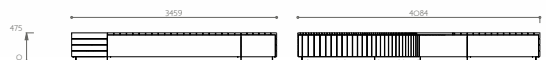

**Square with rounded section**

Ref. 50 0111

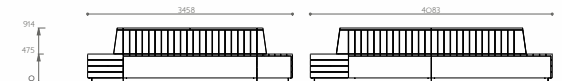

# Mobile planters

**Design:** Sineu Graff

**Materials:**

Peripheral seating: stained or unstained hardwood

Cladding: Zinc and powder coated steel

Growing tubs: Galvanised steel

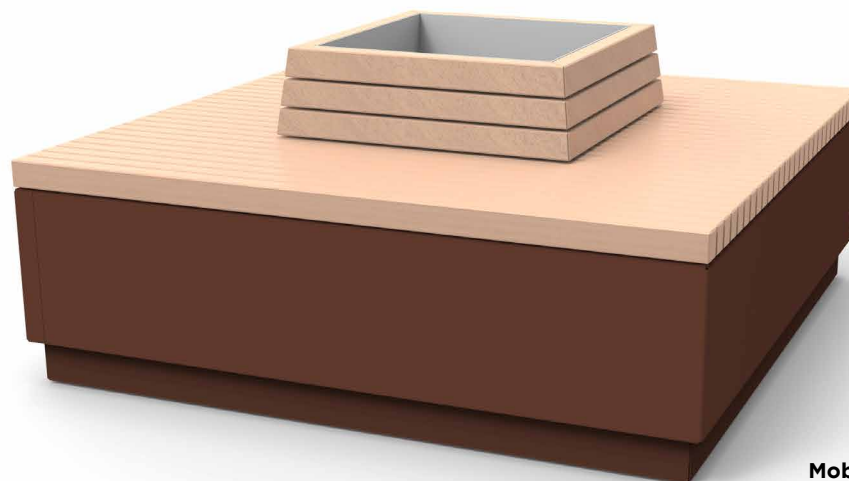

**Mobile planter with full seat**  
Ref. 52 3140

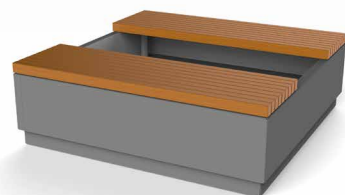

**Mobile planter with 2 seats**  
Ref. 52 3020



**Mobile planter without seatings**  
Ref. 52 3000

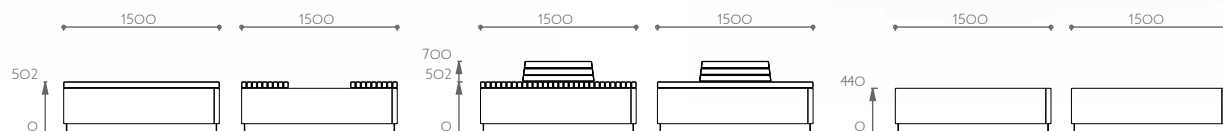

# Ylozen

**Design:** Arturo ERBSMAN

**Materials:**

Seating: unstained hardwood

Cladding: Zinc and powder coated steel

Growing tray: Galvanised steel



**Podium wide leaf**  
Ref. 17 0102



**Podium leaf**  
Ref. 17 0101



**Wide curved leaf**  
Ref. 17 0202



**Wide leaf with planter**  
Ref. 17 0112

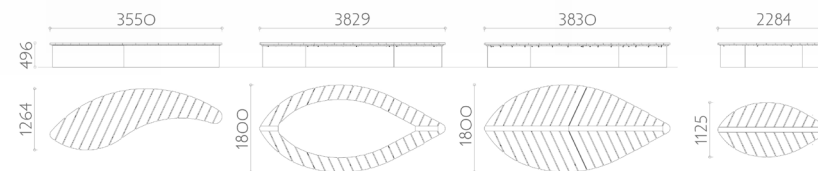



Ylozen



Photo credits: Anne Lena Tande Sandersen

**Mobile Gardens**  
Bamble - Norway

**Steel Garden**  
Brignais - 69 - France



**Ylozen**  
Meaux - 77 - France

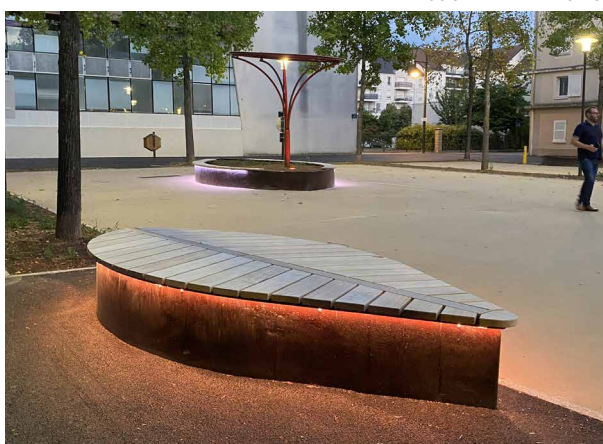

**Mobile planter**  
Vélizy-Villacoublay - 78 - France





**Mobile Gardens**  
Meaux - 77 - France

**Ylozen**  
Deuil-la-Barre - 95 - France



**Steel Garden**  
La Ferté-sous-Jouarre - 77 - France

# Volubilis

**Design:** Vincent MAYOT - Agence Mayot et Toussaint

**Materials:**

Zinc and powder coated steel

Stainless-steel mesh

Available pre-equipped  
with inspection hatch  
and removable cowl.

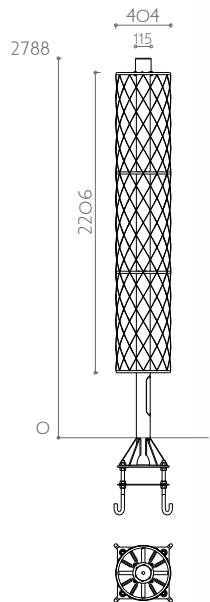

**Freshness column**  
Ref. 17 0801 OM10 APO0

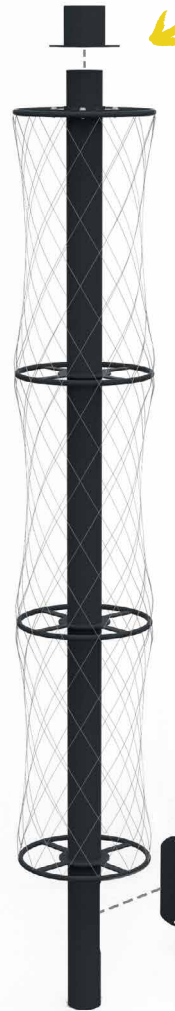

**Freshness column  
pre-equipped**  
Ref. 17 0801 OM10 AP01

**Examples of configurations:**

**Random**

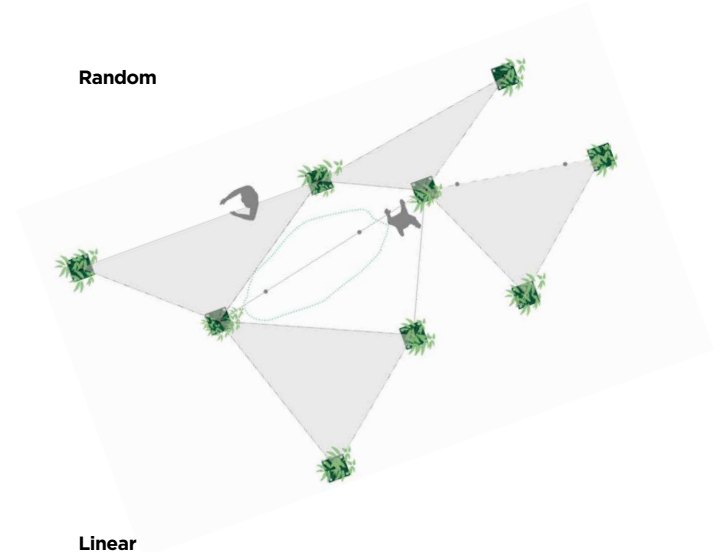

**Linear**

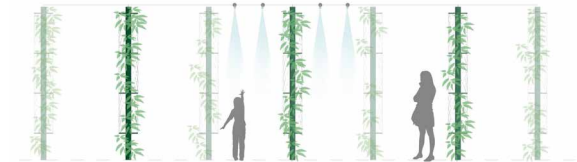

**Staggered**

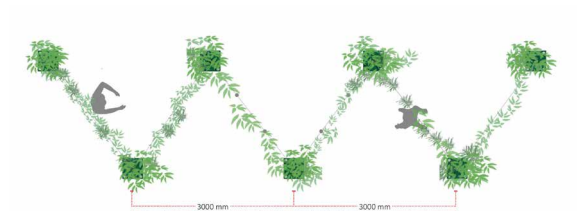



Volubilis

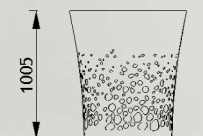
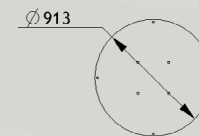

**Pebbles pot 410 L**  
Ref. 19 0010

# Urban Vases

**Design:** Sineu Graff

**Materials:**

Zinc and powder coated steel  
 Growing tubs: galvanised steel  
 or rotomoulded HDPE (Daisy)  
 Powder coated cast iron  
 for the Pebbles pot



**Graphic vase**

18 L: Ref. 0299 725 GRA  
 56 L: Ref. 0299 705 GRA  
 112 L: Ref. 0299 715 GRA  
 210 L: Ref. 0299 735 GRA



**Classic Vase**

18 L: Ref. 299,725  
 56 L: Ref. 299,705  
 112 L: Ref. 299,715  
 210 L: Ref. 299,735



**Daisy vase**

265 L: Ref. 299,700  
 420 L: Ref. 299,710

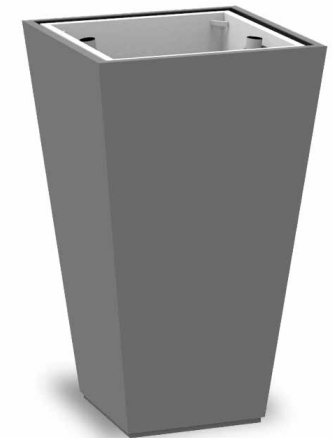

**Pyramid vase**

270 L: Ref. 0299 755

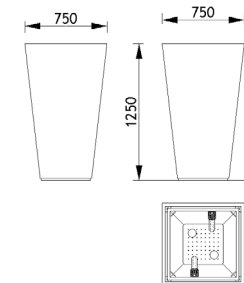
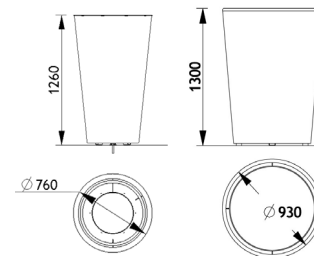
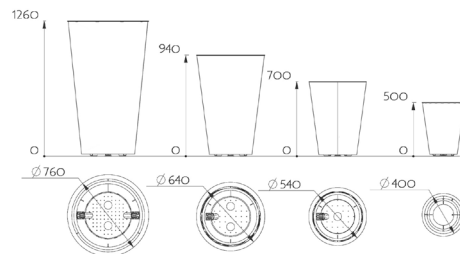
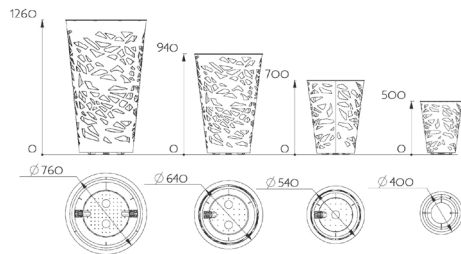



**Urban graphic vase**  
Meaux - 77 - France



**Steel conical planter**  
Beauvais - 60 - France

**Corten®-type steel earth retainer**  
Colmar - 68 - France





**Pebbles pots**  
Sainte Adresse - 76 - France

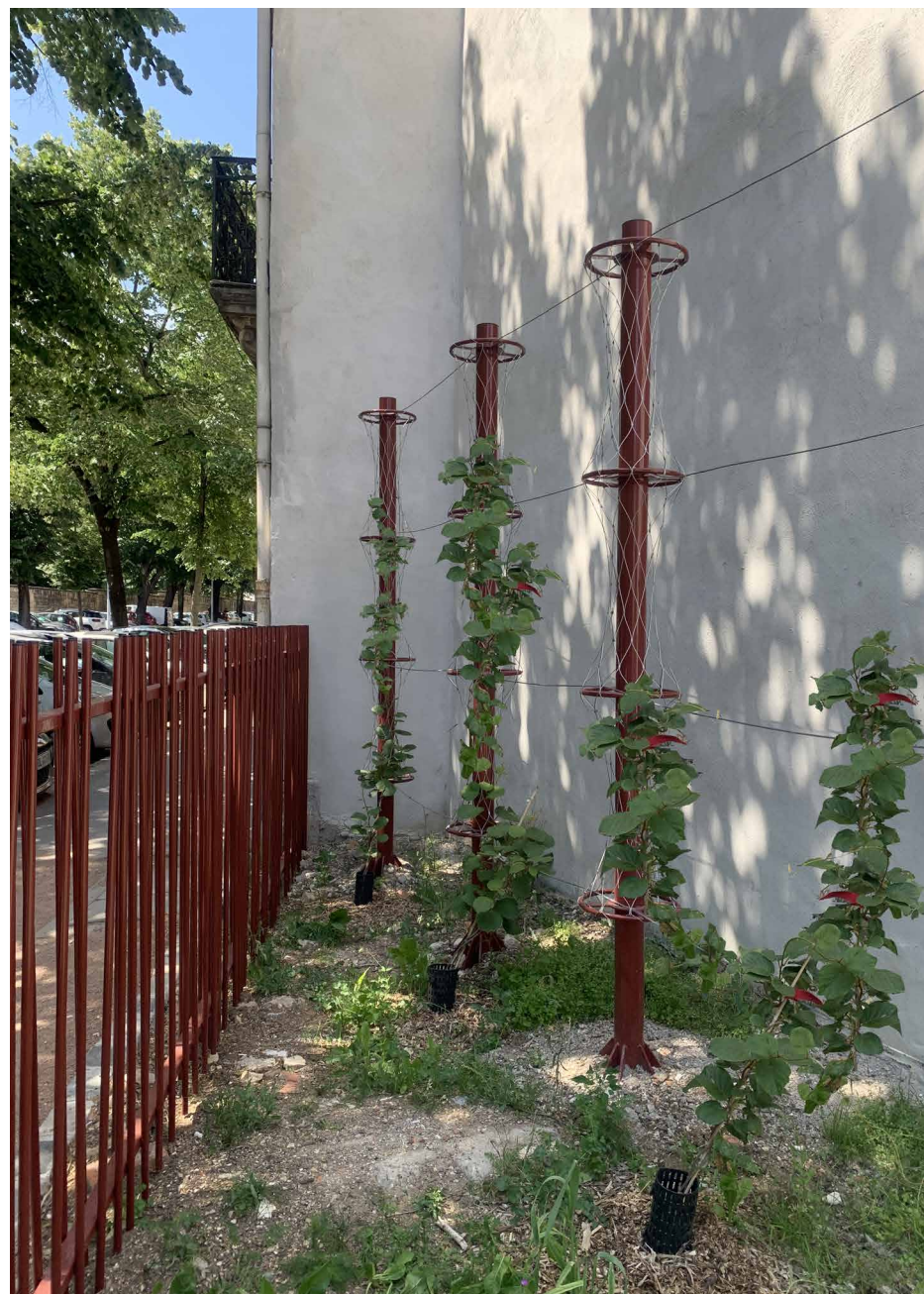

**Volubilis**  
Dijon - 21 - France



**Daisy urban vases**  
Seynod - 74 - France

# Steel planters

## Materials:

Facades and posts: Zinc and powder coated steel  
 Growing tubs: galvanised steel or rotomoulded HDPE (depending on model)  
 Adjustment feet: stainless steel



### Optima Nature planter

57 x 57 x H61: Ref. 299 530M NAT  
 57 x 120 x H61: 299 531M NAT  
 87 x 87 x H93: 299 532M NAT  
 108 x 108 x H93: 99 533M NAT  
 134 x 134 x H128: Ref. 299 534M NAT

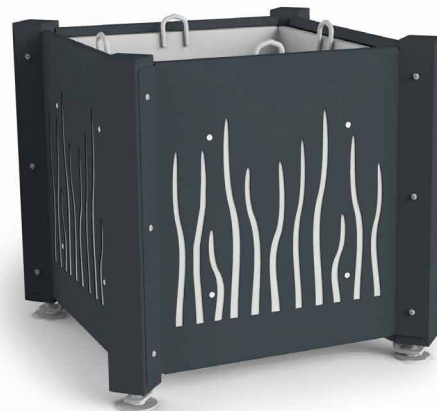
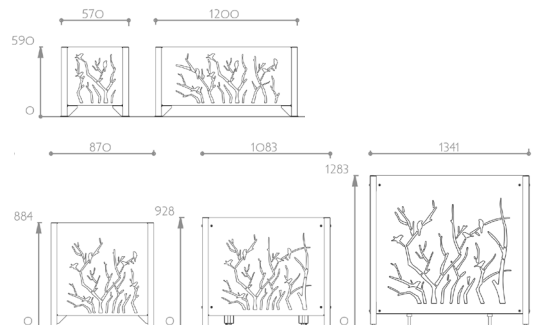

### Roots planter

64 x 64 x H64: Ref. 299 673  
 64 x 128 x H64: Ref. 299 674  
 92 x 92 x H90: Ref. 299 578  
 110 x 110 x H95: Ref. 299 ,677  
 140 x 140 x H120: Ref. 299 ,676

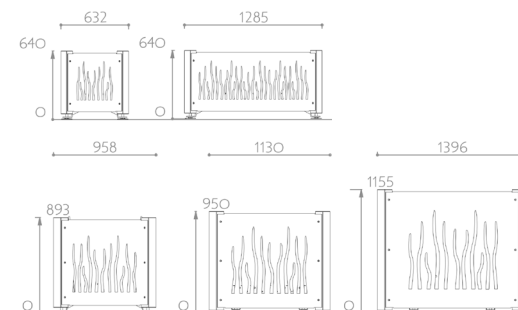

### Optima Graphic planter

57 x 57 x H61: Ref. 0299 530M GRA  
 57 x 120 x H61: 0299 531M GRA  
 87 x 87 x H93: 0299 532M GRA  
 108 x 108 x H93: 299 533M GRA  
 134 x 134 x H128: Ref. 299 534M GRA

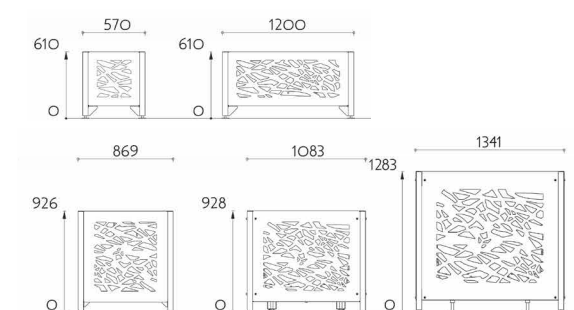

# Steel planters



**Materials:**  
 Facades and posts: Zinc and powder coated steel or Corten®-type weathering steel  
 Growing tubs: Galvanised steel or rotomoulded HDPE (depending on models)  
 Adjustment feet: stainless steel



## Optima steel planter

57 x 57 x H59: Ref. 299 530M  
 57 x 120 x H59: Ref. 299 531M  
 87 x 87 x H88: Ref. 299 532M  
 108 x 108 x H93: Ref. 299 533M  
 134 x 134 x H128: Ref. 299 534M

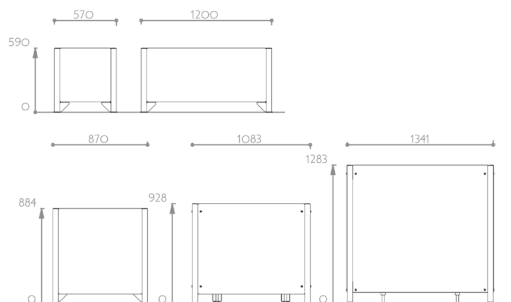

## Steel square planter

55 x 55 x H53: Ref. 299 520 CORTEN  
 55 x 118 x H53: Ref. 299 521 CORTEN  
 84 x 84 x H78: Ref. 299 522 CORTEN  
 101 x 101 x H92: Ref. 299 523 CORTEN  
 128 x 128 x H114: Ref. 299 524 CORTEN

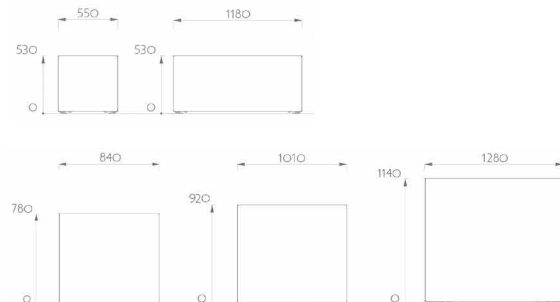

## Steel conical planter

90 x 90 x H86: Ref. 0299 780 SB4P CORTEN  
 140 x 140 x H110: Ref. 0299 790 SB4P CORTEN

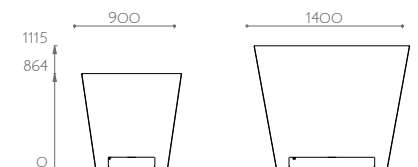

# Wooden planters

## Materials:

Casing: raw or stained exotic wood  
 Posts: Zinc and powder coated steel  
 Growing tray: galvanised steel or rotomoulded HDPE (depending on model)  
 Adjustment feet: stainless steel  
 Cast aluminium balls



### Evolution Roseaie planter

61 x 61 x H71: Ref. 299 650\_VSB  
 61 x 124 x H71: Ref. 299 655\_VSB  
 92 x 92 x H98: Ref. 299 561\_VSB  
 110 x 110 x H109: Ref. 299 564\_VSB  
 137 x 137 x H29: Ref. 299 656\_VSB

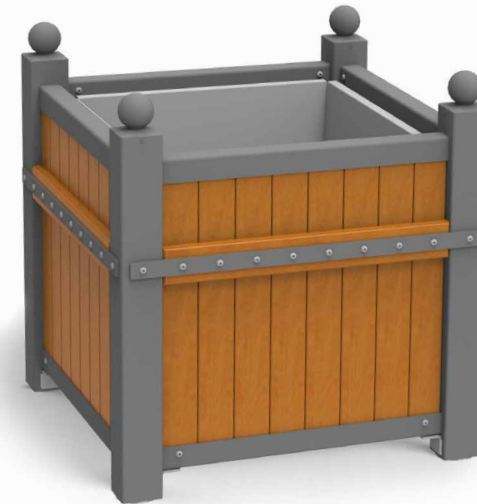

### Roseaie planter

62 x 62 x H71: Ref. 299 650  
 62 x 125 x H71: Ref. 299 655  
 93 x 93 x H98: Ref. 299 561  
 110 x 110 x H109: Ref. 299 564  
 138 x 138 x H129: Ref. 299 656

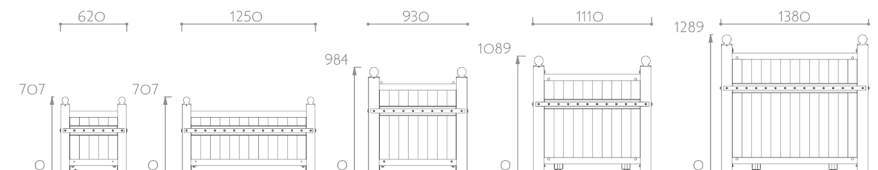
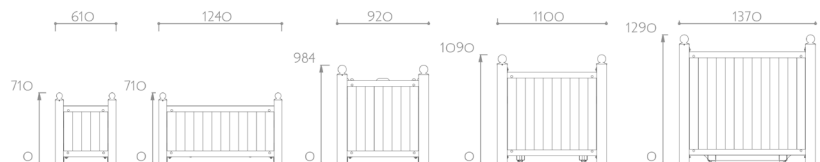

# Wooden planters

## Materials:

Casing: raw or stained exotic wood  
 Posts: Zinc and powder coated steel  
 Growing tray: galvanised steel or rotomoulded HDPE (depending on model)  
 Adjustment feet: stainless steel



**Marquise planter**  
 65 x 65 x H78: Ref. 299 680  
 65 x 128 x H78: Ref. 299 685  
 92 x 92 x H102: Ref. 299 681  
 110 x 110 x H111: Ref. 299 684  
 137 x 137 x H131: Ref. 299 686



**Optima planter**  
 58 x 58 x H61: Ref. 299 530  
 58 x 121 x H61: Ref. 299 531  
 88 x 88 x H95: Ref. 299, 532  
 104 x 104 x H95: Ref. 299 533  
 135 x 135 x H129: Ref. 299 534

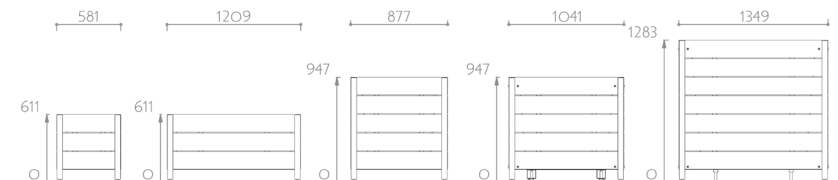
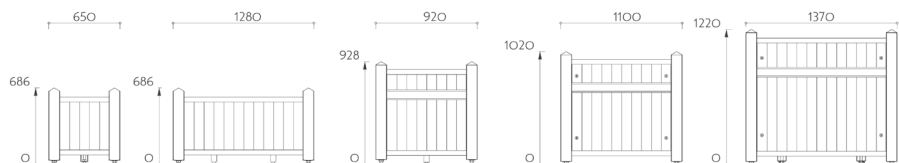



**Roseaie planters**  
Sartrouville - 78 - France

**Optima planters**  
Lieuxaint - 77 - France



**Roots planters**  
Carry-le-Rouet - 13 - France



**Roots planters**  
Istres - 13 - France





**Customized planters**  
Issy-les-Moulineaux - 92 - France



**Graphic planters**  
Meaux - 77 - France

# Steel Tree grilles

## Materials:

Zinc and powder coated steel  
Standard or reinforced peripheral frame  
Optional Staking shoe(s), irrigation hatch(es)  
and spot reservation(s)



## Gaia



1.20 x 1.20 m: Ref. 42 320C03  
1.50 x 1.50 m: Ref. 42 350C03  
1.80 x 1.80 m: Ref. 42 380C03



1.80 x 1.50 m: Ref. 42 358AC03

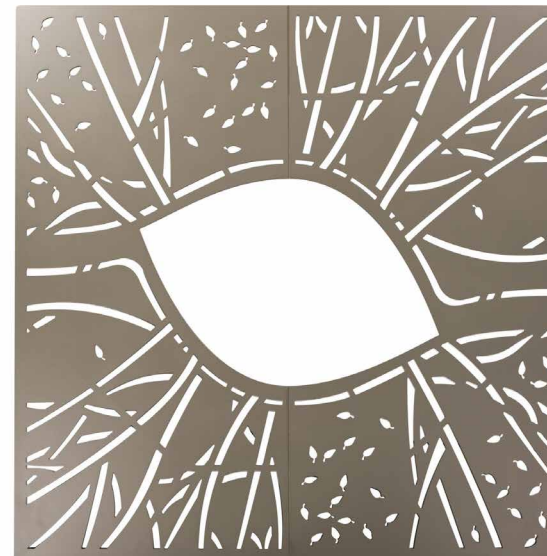
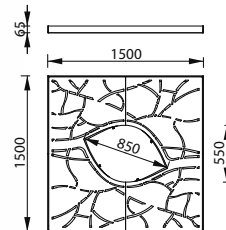

## Karma



1.20 x 1.20 m: Ref. 42 320C06  
1.50 x 1.50 m: Ref. 42 350C06  
1.80 x 1.80 m: Ref. 42 380C06



1.80 x 1.50 m: Ref. 42 358AC06

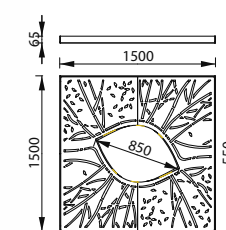

# Steel Tree grilles

## Materials:

Zinc and powder coated steel  
 Standard or reinforced peripheral frame  
 Optional Staking shoe(s), irrigation hatch(es)  
 and spot reservation(s)

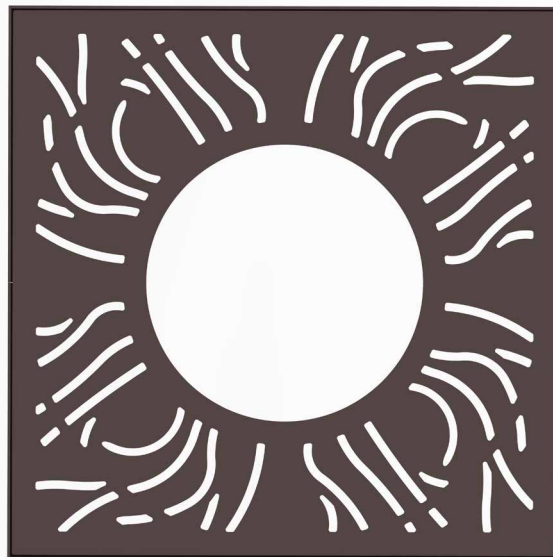

## Roots



1.20 x 1.20 m: Ref. 42 22C05 GR PMR  
 1.50 x 1.50 m: Ref. 42 25C05 GR PMR  
 1.80 x 1.80 m: Ref. 42 28C05 GR PMR



Ø 1.20 m: 42 22R05 GR PMR  
 Ø 1.50 m: 42 25R05 GR PMR  
 Ø 1.80 m: 42 28R05 GR PMR

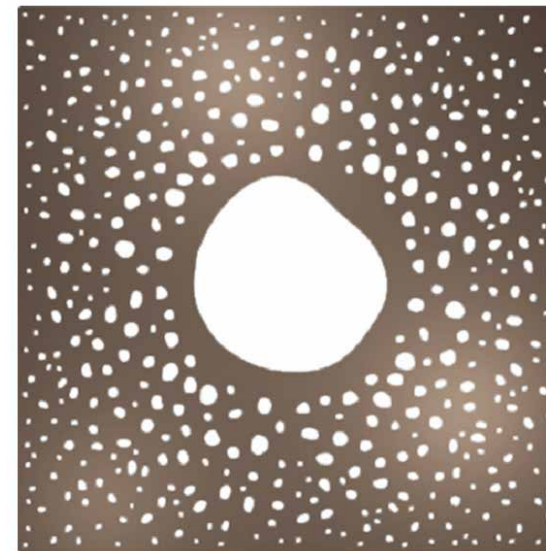
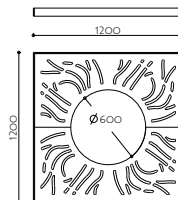

## Pebbles



1.20 x 1.20 m: Ref. 42 22C04 GR PMR  
 1.50 x 1.50 m: Ref. 42 25C04 GR PMR  
 1.80 x 1.80 m: Ref. 42 28C04 GR PMR



Ø 1.20 m: 42 22C04 GR PMR  
 Ø 1.50 m: 42 25C04 GR PMR  
 Ø 1.80 m: 42 28C04 GR PMR

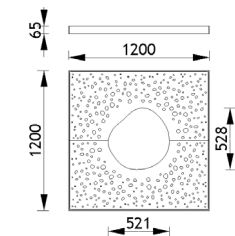

# Cast iron Tree grilles

## Material:

Powder coated cast iron  
 Standard or reinforced peripheral frame  
 Optional Staking shoe(s), irrigation hatch(es)  
 and spot reservation(s)

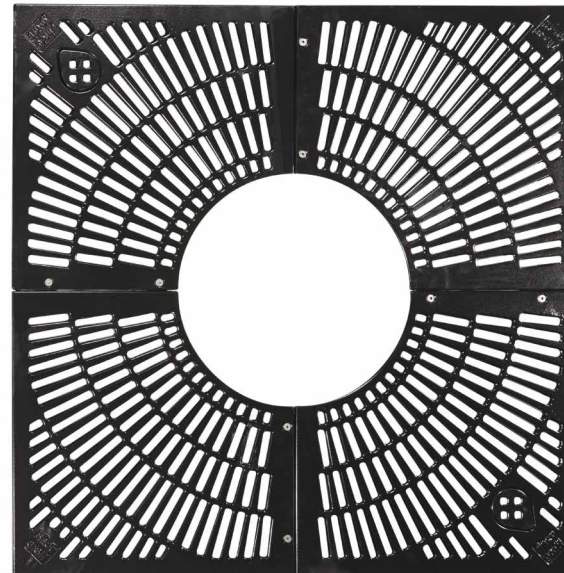
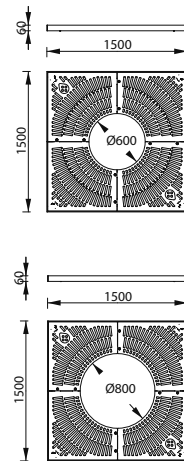

## Classical



Opening 0.60m  
 1.50 x 1.50 m: 42 4520  
 1.80 x 1.80 m: 42 4510

Opening 0.80m  
 1.50 x 1.50 m: 42 4540  
 1.80 x 1.80 m: 42 4530

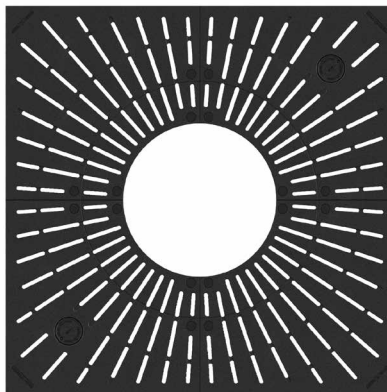
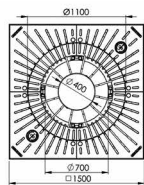

## Diagonal - MEIERGUSS

1.25 x 1.25 m: Ref. 42 6501 NEW  
 1.50 x 1.50 m: Ref. 42 6502 NEW  
 1.80 x 1.80 m: Ref. 42 6503 NEW  
 2.00 x 2.00 m: Ref. 42 6505 NEW



Ø 1.50 m: Ref. 42 6512 NEW  
 Ø 2.00 m: Ref. 42 6513 NEW

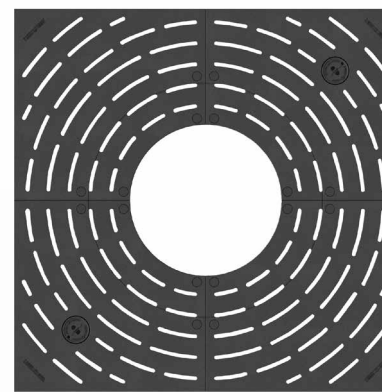
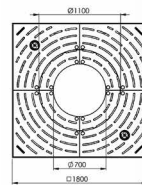

## Radial - MEIERGUSS

1.25 x 1.25 m: Ref. 42 6601 NEW  
 1.50 x 1.50 m: Ref. 42 6602 NEW  
 1.80 x 1.80 m: Ref. 42 6603 NEW  
 2.00 x 2.00 m: Ref. 42 6605 NEW



Ø 1.50 m: Ref. 42 6612 NEW  
 Ø 2.00 m: Ref. 42 6613 NEW

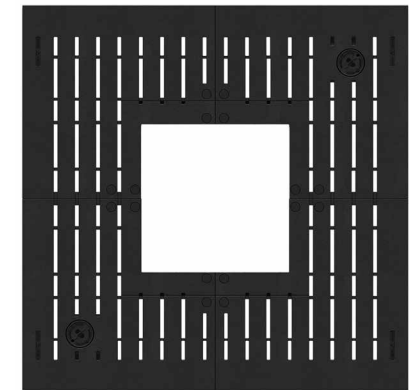
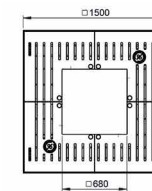

## Lateral - MEIERGUSS

1.25 x 1.25 m: Ref. 42 6401 NEW  
 1.50 x 1.50 m: Ref. 42 6402 NEW  
 1.80 x 1.80 m: Ref. 42 6403 NEW  
 2.00 x 2.00 m: Ref. 42 6405 NEW



# Cast iron Tree grilles

**Material:**

Powder coated cast iron  
 Standard or reinforced peripheral frame  
 Optional Staking shoe(s), irrigation hatch(es)  
 and spot reservation(s)

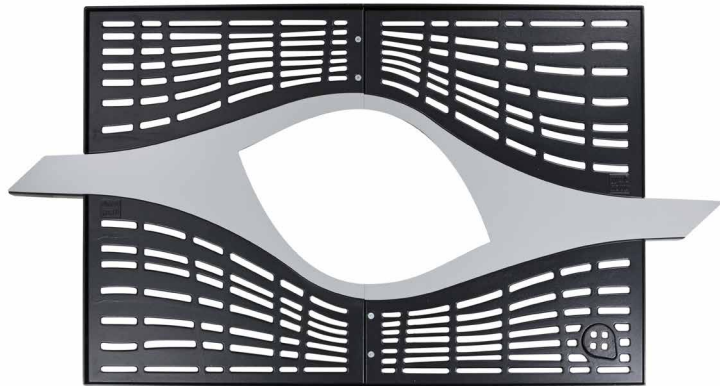

**Horus 1**  
 Ref. 42 428A01 GR

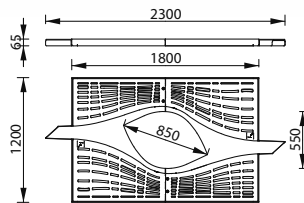

**Horus 2**  
 Ref. 42 428A02 GR

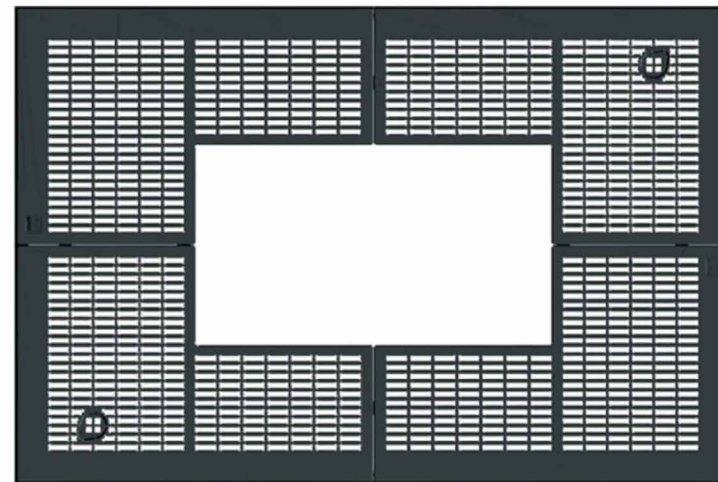
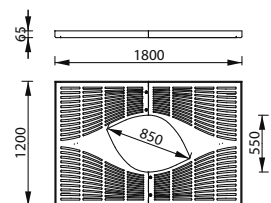

**Contemporary**

Opening 0.60m  
 1.50 x 1.50 m: 42 4620  
 1.80 x 1.80 m: 42 4610

Opening 0.80m  
 1.50 x 1.50 m: 42 4640  
 1.80 x 1.80 m: 42 4630

3.00 x 2.00 m: 42 4662

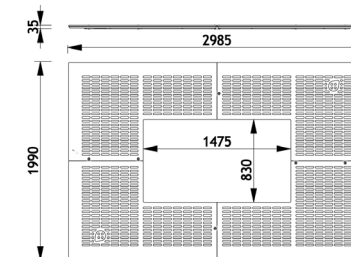



**Tree guard 5100**  
Ref. 42 5102

**Tree grille Radial**  
Ref. 42 6602 NEW

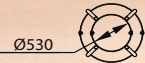
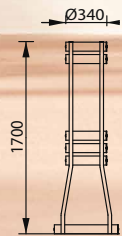

# Tree guards

**Material:**  
Zinc and powder coated steel

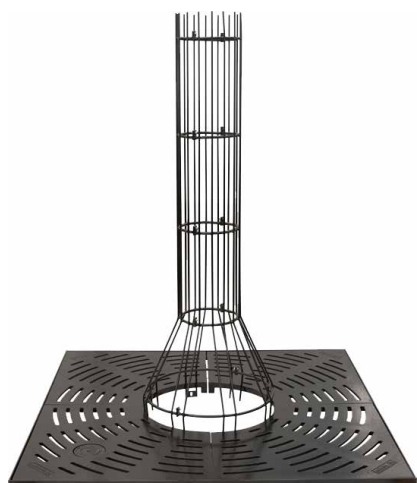

**Tree guard 5000**  
Ref. 42 5000

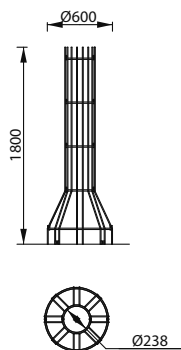

**Tree guard 5200**  
Ref. 42 5200

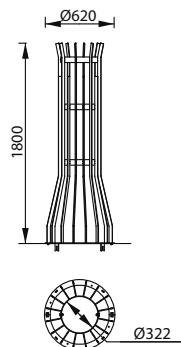

**Tree guard 3000**  
Ref. 42 3000

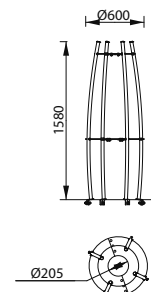

**Tree guard 3200**  
Ref. 42 3200

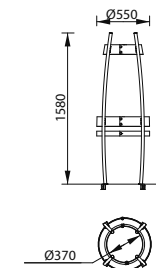



**Roots Tree grille**  
Beaulieu-sur-Mer - 06 - France

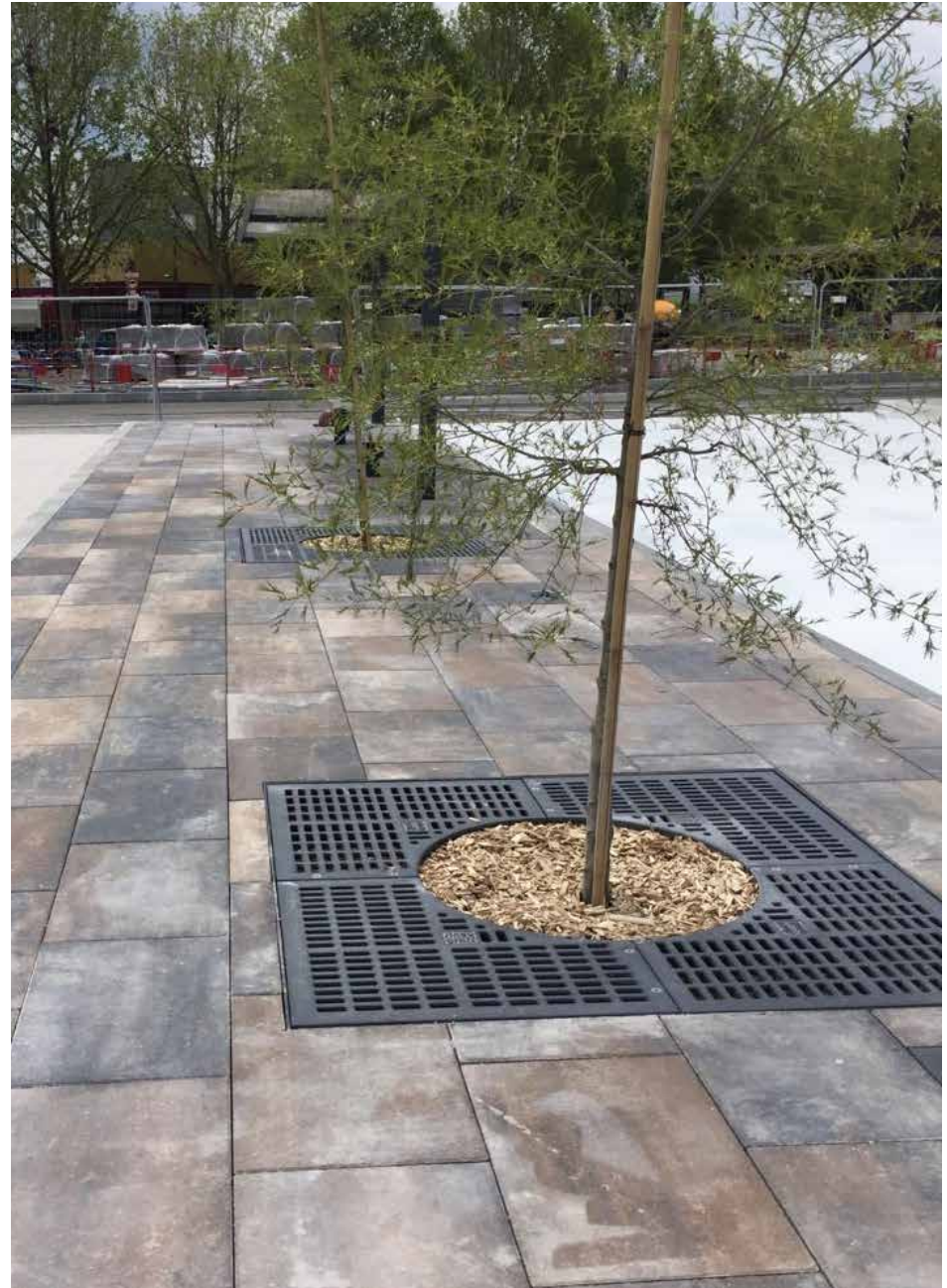

**Contemporary Tree grille**  
Louviers - 27 - France

**Customized Tree grille and guard**  
Besançon - 25 - France





**Horus Tree grille**  
Dunkirk - 59 - France



**Customized Tree grille**  
City of Luxembourg

**Roots Tree grille**  
Tremblay-en-France - 93 - France



# Safe city

## No limit to safety

Discreetly positioned posts, barriers and bollards stand sentinel, guarding pedestrians and travellers in increasing numbers.  
Their magical operation, their orchestrated fluidity, keeps cars, bicycles, scooters and pushchairs in their proper place.  
Their muted presence soothes, protective without being intrusive, preserving our well-being, calming the commotion.  
Street furniture, strategically placed, inspires confidence and peace of mind, a subtle blend of restraint and obviousness.  
Essential symbols of a city in harmony.





# Bicycle racks

## Material

Zinc and powder coated or galvanised steel (Link)  
 Unstained hardwood or larch, stained ash

Fixing: on tube  
 or on base plate



**Single silhouette**  
 Ref. 43 50X1

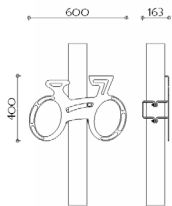

**Double silhouette**  
 Ref. 43 50X2

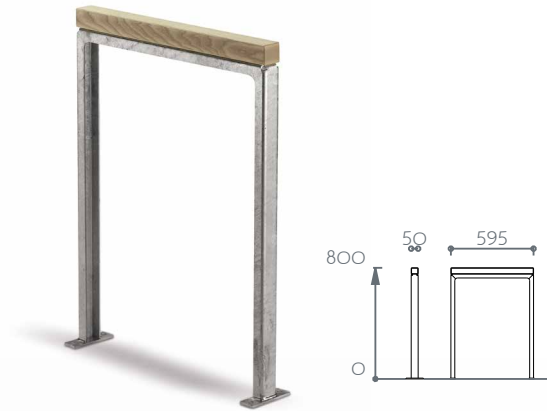
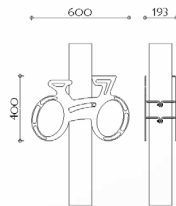

**Link**  
 Ref. 11 0560

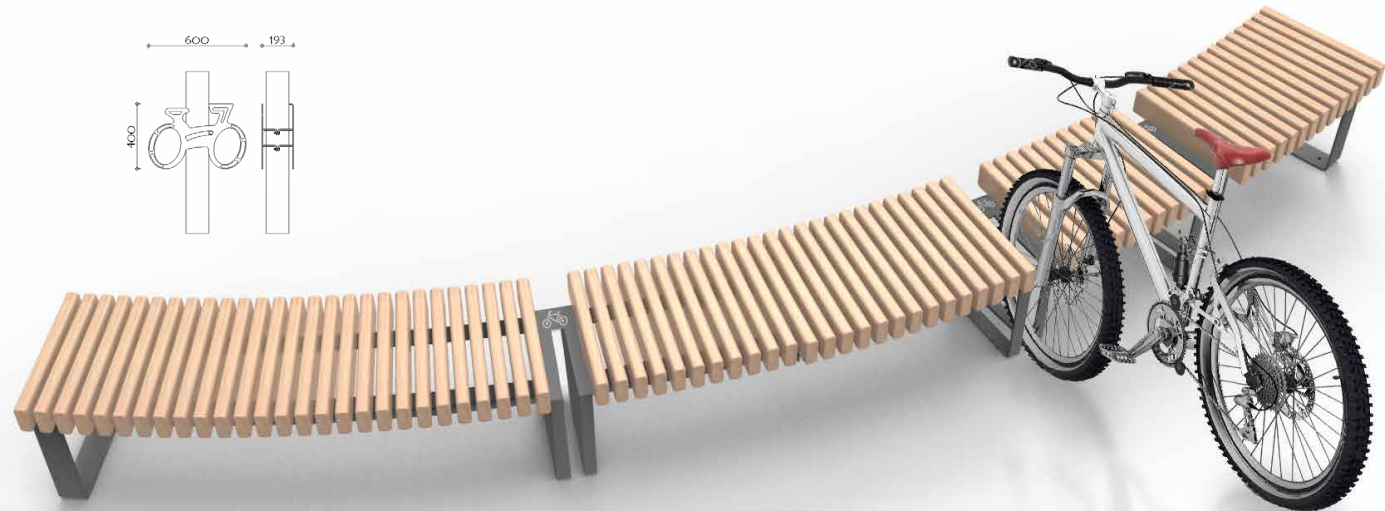

**Customized Affinité**

# Bicycle racks

## Materials

Zinc and powder coated steel

Fixing on tube  
or on base stand



**U tube**  
Ref. 43 0200

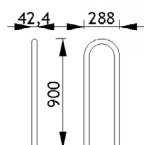

**U flat steel, slim**  
Ref. 43 4001

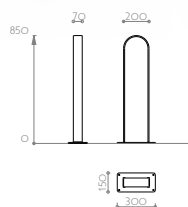

**U flat steel, wide**  
Ref. 43 4011

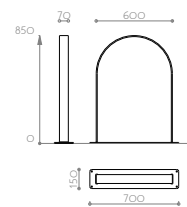

**with cutout**  
Ref. 43 0175

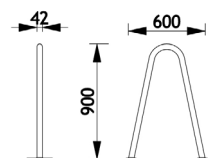

**with cutout**  
Ref. 43 0165

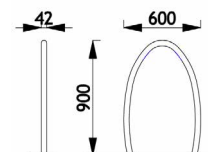

**with cutout**  
Ref. 43 0155

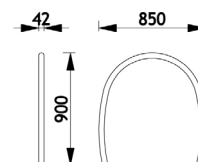

**Square ARCH**  
Ref. 43 0131

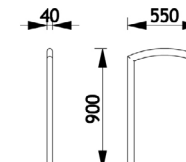



Scooter stand

# Scooter racks

**Material:**

Zinc and powder coated steel or stainless steel

Fixing on tube or on base plate



**4-place single racks**  
Ref. 43 204X



**6-place single racks**  
Ref. 43 206X



**8-place double racks**  
Ref. 43 214X

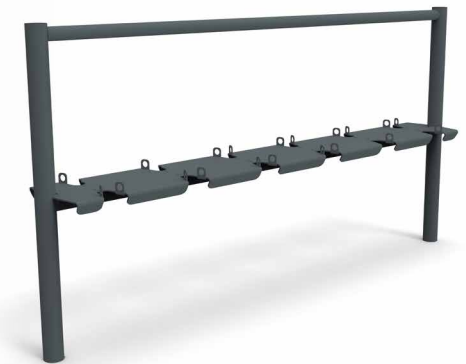

**12-place double racks**  
Ref. 43 216X

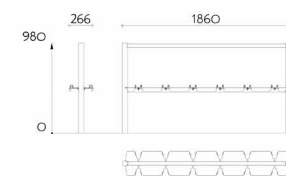
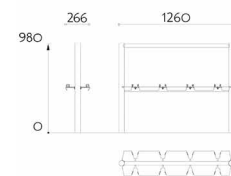
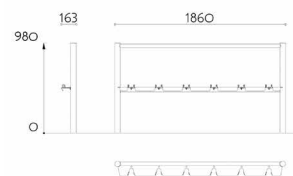
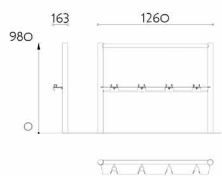



**Silhouette Bicycle rack**  
Saint Briec - 22 - France

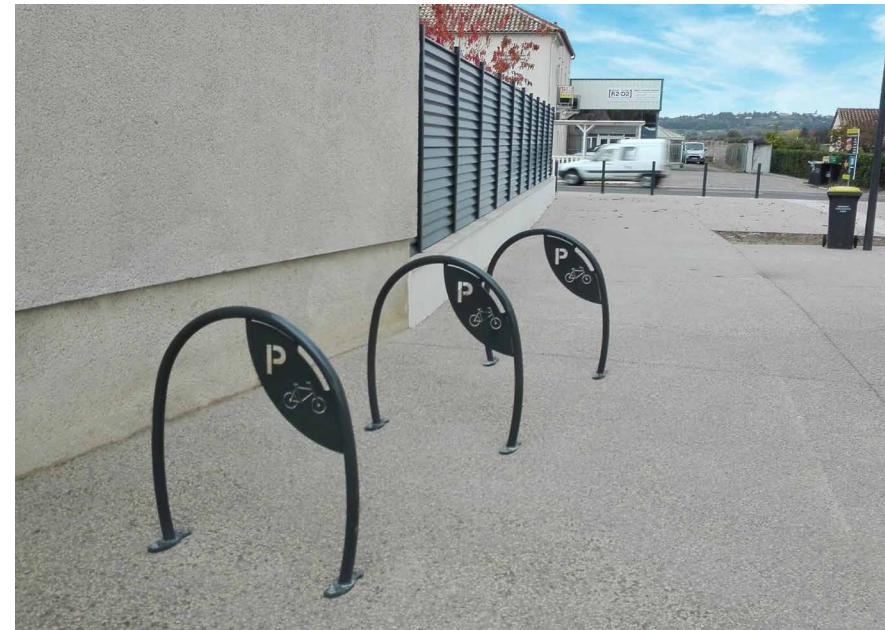

**Wide arches**  
Brax - 47 - France

**Scooter racks**  
Sartrouville - 78 - France

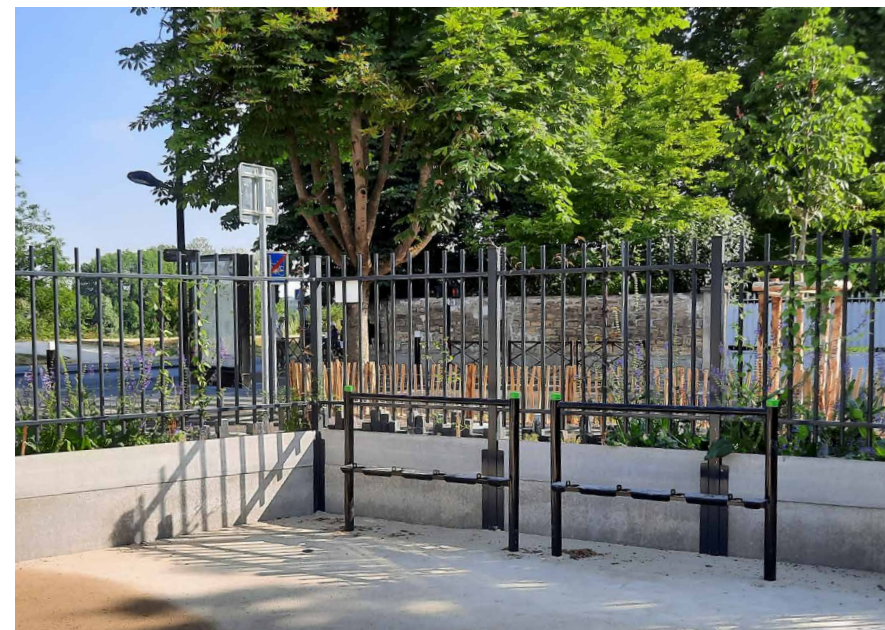



**Link Bicycle racks**  
Ribeauvillé - 68 - France

**Silhouette Bicycle rack**  
Lille - 59 - France



**Link Bicycle racks**  
Misk City - Saudi Arabia

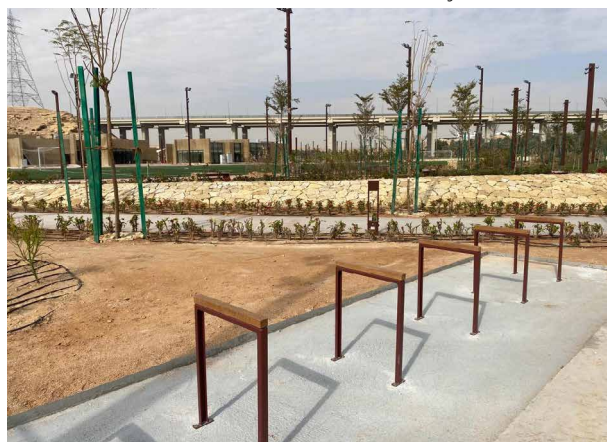

**Square arches**  
Le-Perreux-sur-Marne - 94 - France

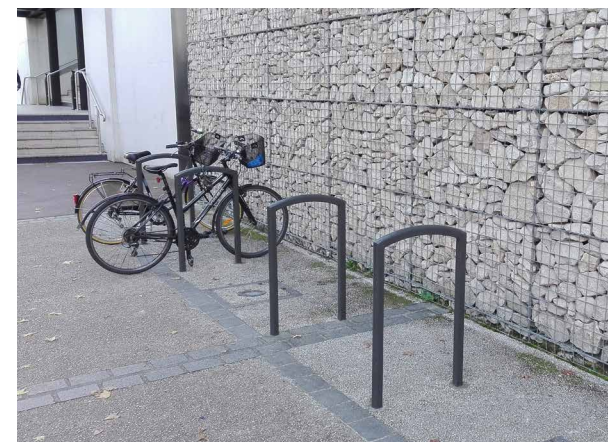

# Bollards

## Materials:

Zinc and powder coated steel or stainless steel

Powder coated cast iron

Depending on the model: cap in cast aluminium or stainless steel

Fixing on tube, on base plate or removable



## Cast iron



**Cast iron  
Style 3400**  
Ref. 40 341X NW



**Cast iron  
Classic 3500**  
Ref. 40 351X NW



**Cast iron  
Contemporary  
3300**  
Ref. 40 337X

## Stainless steel



**Stainless-steel  
5000**  
Ref. 40 503X



**Stainless-steel  
5000**  
Ref. 40 505X i



**Stainless-steel  
5000**  
Ref. 40 505X

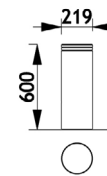
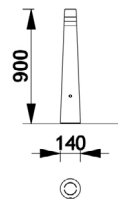
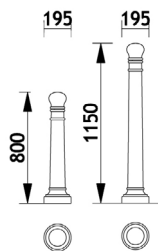
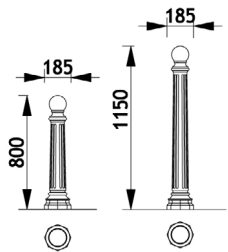

# Bollards

## Materials:

Zinc and powder coated steel or stainless steel

Powder coated cast iron

Depending on the model: cap in cast aluminium or stainless steel

Fixing on tube, on base plate or removable

## Steel



**Stainless-steel  
5000**  
Ref. 40 505XA

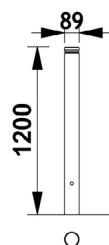

**Steel  
2100**  
Ref. 40 212X

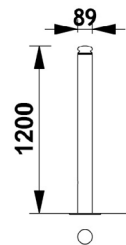

**Steel  
2200**  
Ref. 40 222X

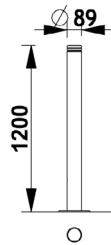

**Steel  
2300**  
Ref. 40 232X

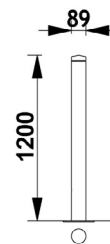

**Steel  
3200**  
Ref. 40 329X



**Steel  
3200**  
Ref. 40 328X



**Steel  
5200**  
Ref. 40 544X C.B.

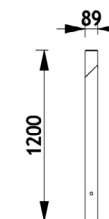



**Bollards series 5200**  
Istres - 13 - France

**Bollards series 2000**  
Chaumuzey - 51 - France



**Cast iron bollards 3300**  
Valenton - 94 - France



**Steel bollards 5200**  
Mennecy - 91 - France





**Stainless-steel bollards 5000**  
Doha - Qatar



**Cast iron bollards Style 3400**  
Cannes - 06 - France

**3300 barriers and 5200 steel bollards**  
Menecy - 91 - France



# Barriers

## Materials:

Zinc and powder coated steel  
Caps in painted cast aluminum

Fixing on tubes, on base plates  
or removable

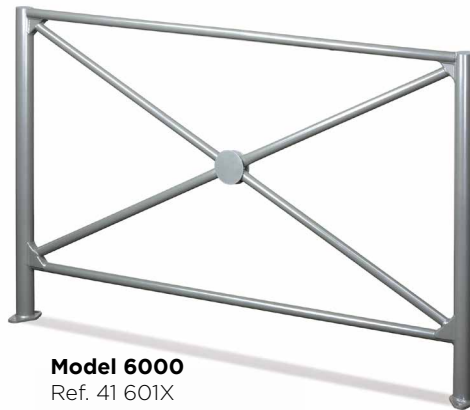

**Model 6000**  
Ref. 41 601X

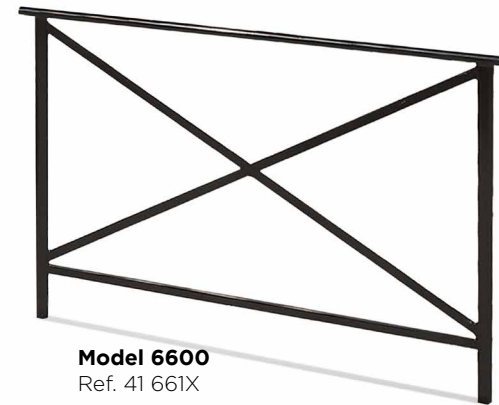
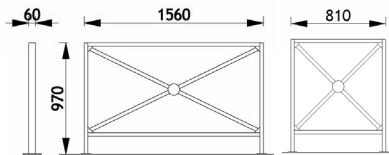

**Model 6600**  
Ref. 41 661X

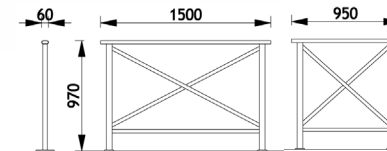

**Model 2300**  
Ref. 41 233X

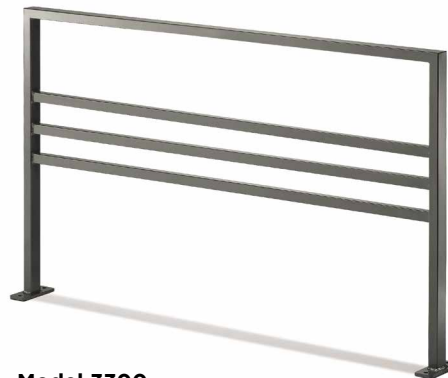
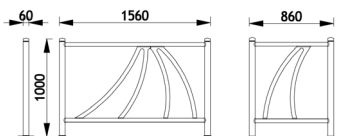

**Model 3300**  
Ref. 41 331X

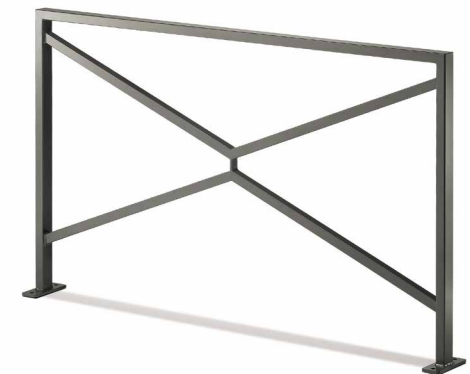
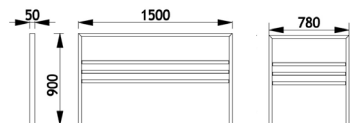

**Model 3000**  
Ref. 41 301X

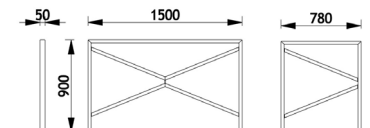

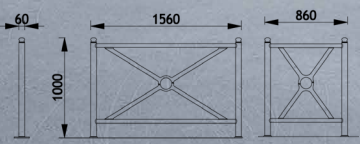

**Model 2100**  
Ref. 41 X 211 M



**Barriers 3300**  
Mennecey - 91 - France



**Barriers 2300**  
Colomiers - 31 - France

**Barriers 2100**  
Plessis-Collegien - 77 - France



**Barriers 2300**  
Niederbronn-les-Bains - 67 - France





**Barriers 2100**  
Lorges - 83 - France



**Barriers 2100**  
Tremblay-en-France - 93 - France

**Barriers 2300**  
Cuers - 83 - France



# Totems

**Design:** Sineu Graff

**Material:**  
Zinc and powder coated steel  
Plexiglas number plate



**Single totem**  
Ref. 63 0011



**Option  
pivoting door**

**Plexiglas  
number plate**



**Double totem**  
Ref. 63 0022

## Available standard patterns



**Evolution**

**Bamboo**

**Roots**

**Graphic**

**Pebbles**

**Customized**

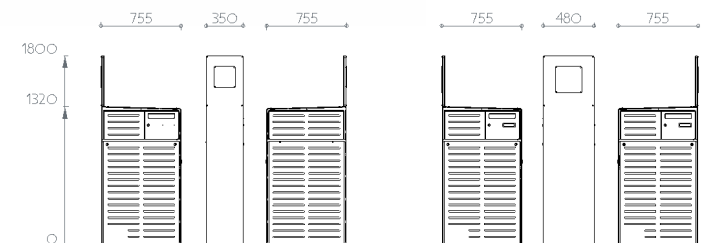

## Cover the unaesthetic boxes

This innovative product lets you dress unsightly boxes (electricity, gas) and improve the exterior design of a building. An integrated plexiglas letterbox and house number make this totem product that combines functionality and design.

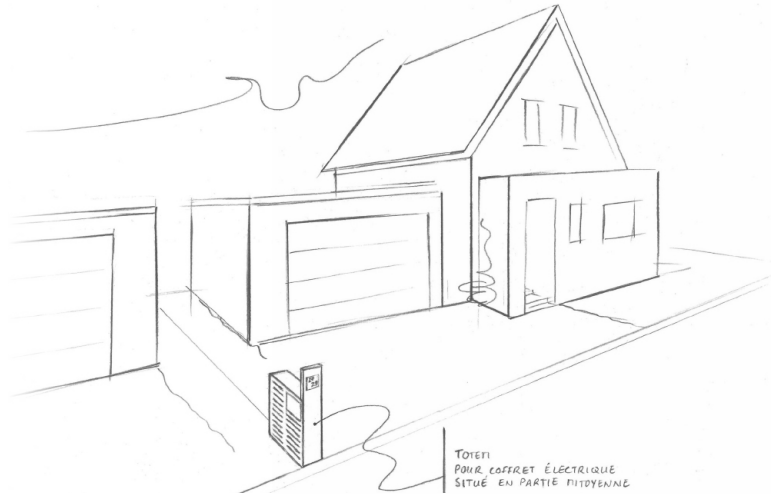

**Totem**  
Duppigheim - 67 - France



# Totems

**Design:** Sineu Graff

**Material:**  
Zinc and powder coated steel  
Plexiglas number plate



The installation of Ylozen secures and calms the space, guarantees the separation of flows and restricts the crossing or intrusion of vehicles.

Combined, the **ready-to-install** Ylozen Feuilles and planters will free up the use of the space and create **shaded, refreshing, calm and safe areas**.

With **Ylozen**, add value to your landscaped projects and transform neglected and impersonal spaces into Comfortable and friendly **urban oases**.

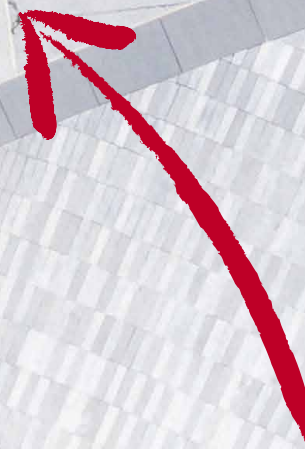

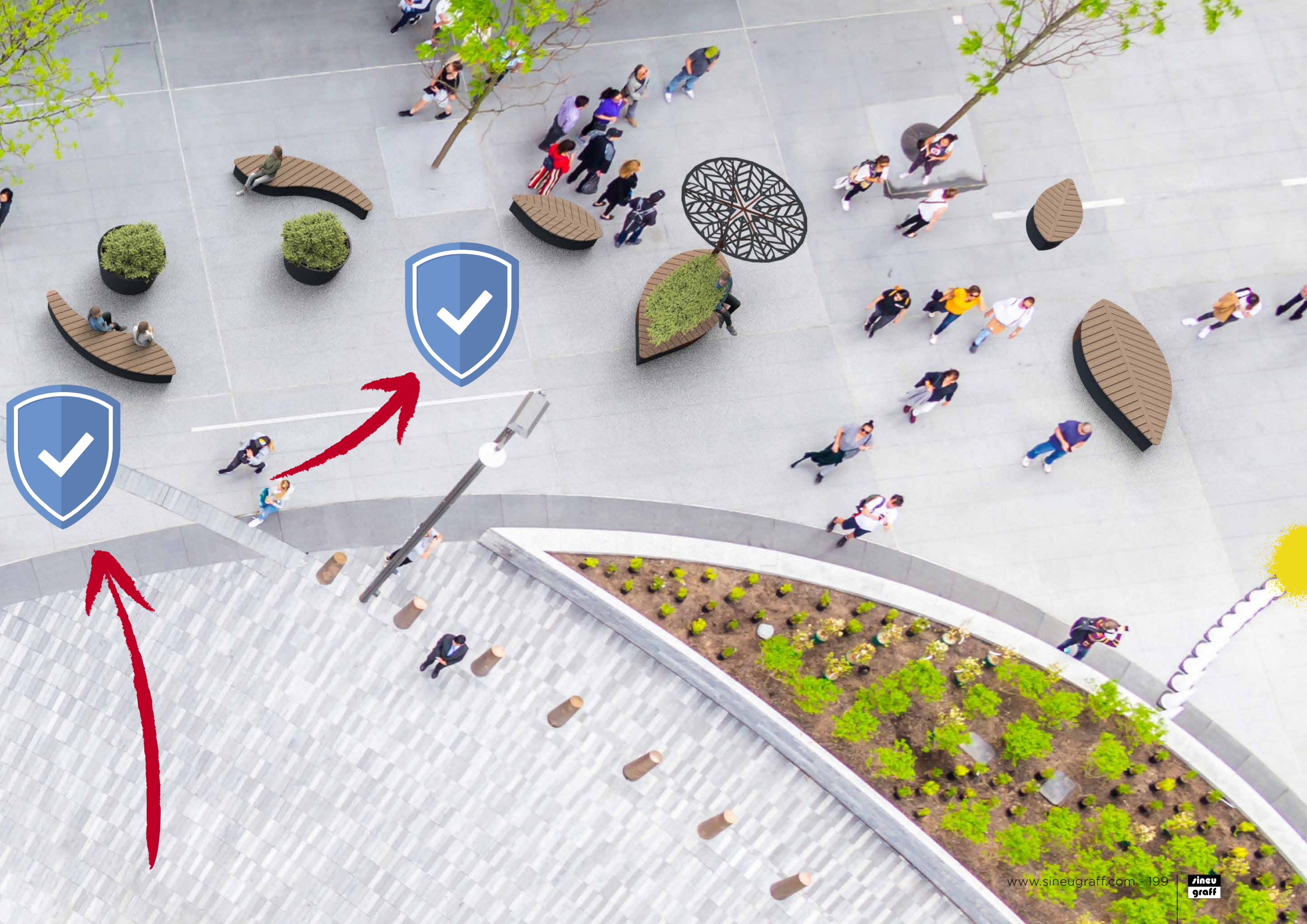

# Lively city

## Let's bring sport to our environment

Sport gains in popularity when available, giving everyone the opportunity for training, self-fulfilment and caring for their well-being. City gardens, taking a more global vision, welcome within their core temples of fitness, training and games for all.

Here, diversity finds its place, adapted to everyone, from children at play to the multisport teenager and seniors looking to keep in shape. The city takes on a lively air, giving everyone the chance to be on the move, free and active, with no physical or age limit. Sheltered under a protective structure, outdoor sports can deal with the vagaries of the weather.

The Mouv'Roc<sup>®</sup>, universal shelter becomes the go-to place for novices and enthusiasts alike, where diversity flourishes within the beauty of sport.





open mouv'roc

龍

# Mouv'roc®

**Design:** Sineu Graff

**Materials:**

Roof: Zinc and powder coated steel

Panels: HPL

Apparatus: galvanised steel and HDPE



**over 200  
installations  
worldwide**



**Mouv'roc® Lion**

Ref. 08 300A

9 simultaneous users

90 exercises

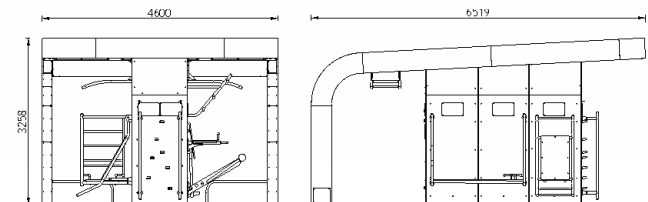

# Mouv'roc®

**Design:** Sineu Graff

**Materials:**

Roof: Zinc and powder coated steel

Panels: HPL

Apparatus: galvanised steel and HDPE



**Mouv'roc® Leopard**  
Ref. 08 100B  
4 simultaneous users  
35 exercises



**Mouv'roc® Rhino**  
Ref. 08 300B  
6 simultaneous users  
55 exercises



**Mouv'roc® Tigre**  
Ref. 08 200B  
6 simultaneous users  
40 exercises

**over 200  
installations  
worldwide**

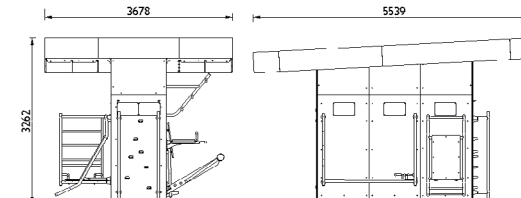
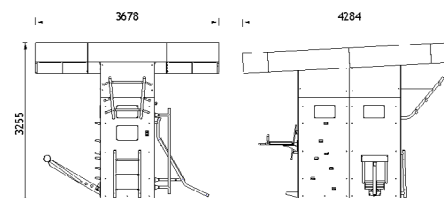
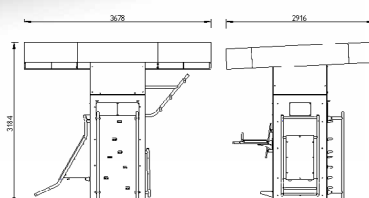

# Open Mouv'roc®

Design: Sineu Graff

over 200  
installations  
worldwide



One big family attentive to each of its member's needs

A warm atmosphere, light and bright

A taut, pure line

More diversity

An open space, welcoming and configurable

Greater accessibility

Original, innovative and adapted apparatus



# Open Mouv'roc®

## UNIVERSAL

**Design:** Sineu Graff

**Materials:**

Roof: Zinc and powder coated steel  
 Panels: HPL  
 Apparatus: galvanised steel and HDPE



**over 200**  
**installations**  
**worldwide**

### Open Mouv'roc® L - UNIVERSAL

Ref. 09 310 02 01  
 12 simultaneous users  
 90 exercises



Configurable space



### Open Mouv'roc® XL - UNIVERSAL

Ref. 09 410 02 01  
 16 simultaneous users  
 102 exercises



Configurable space

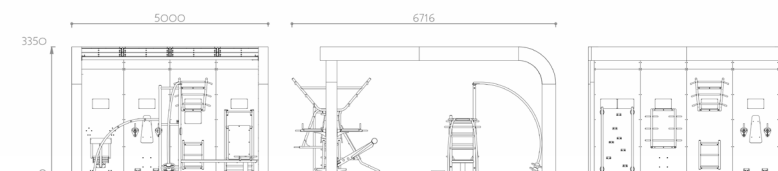
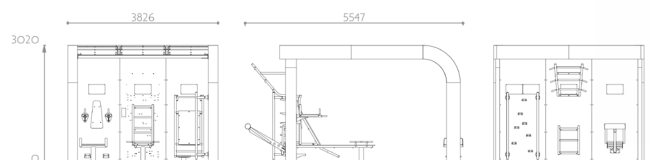

# Open Mouv'roc® SPORT

**Design:** Sineu Graff

**Materials:**

Roof: Zinc and powder coated steel

Panels: HPL

Apparatus: galvanised steel and HDPE



**over 200  
installations  
worldwide**

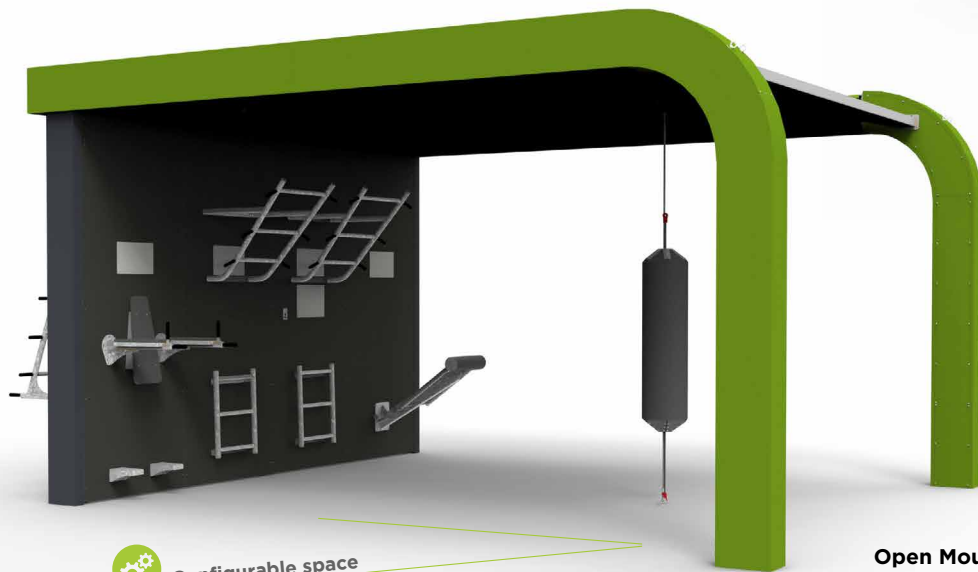

Configurable space



Configurable space



**Open Mouv'roc® L - SPORT**

Ref. 09 310 03 01

12 simultaneous users

90 exercises

**Open Mouv'roc® XL - SPORT**

Ref. 09 410 03 02

13 simultaneous users

94 exercises

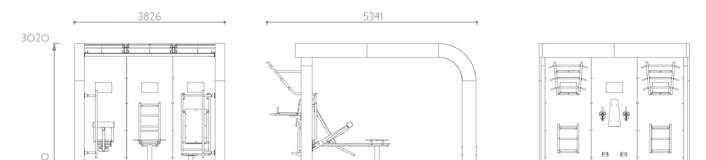
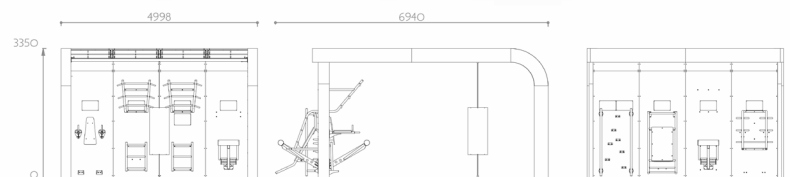

# Open Mouv'roc®

## HEALTH and SENIOR

**Design:** Sineu Graff

**Materials:**

Roof: Zinc and powder coated steel  
 Panels: HPL  
 Apparatus: galvanised steel and HDPE



**over 200  
 installations  
 worldwide**



**Open Mouv'roc® L - SENIOR**  
 Ref. 09 315 04 01  
 8 simultaneous users  
 40 exercises



Configurable space



**Open Mouv'roc® XL - HEALTH**  
 Ref. 09 410 04 06  
 14 simultaneous users  
 97 exercises



Configurable space

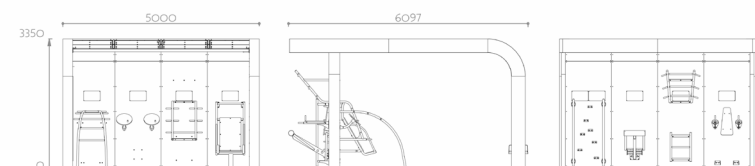
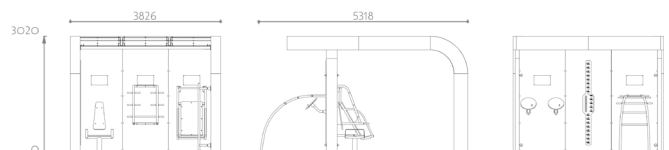

# The Open Mouv'roc® range

Not just sport

## End facade



**XL**

### UNIVERSAL

Ref. 09 410 02 01



**L**

### UNIVERSAL

Ref. 09 310 02 01



## Inner facade



### UNIVERSAL

Ref. 09 415 02 01



### UNIVERSAL

Ref. 09 315 02 00



# The Open Mouv'roc® range

Not just sport

**XL**

## **SPORT**

Ref. 09 410 03 01



**L**

## **SPORT**

Ref. 09 310 03 01



**XL**

## **HEALTH**

Ref. 09 410 04 01



## **SPORT**

Ref. 09 415 03 01



## **SENIOR**

Ref. 09 315 04 01



## **HEALTH**

Ref. 09 415 04 01



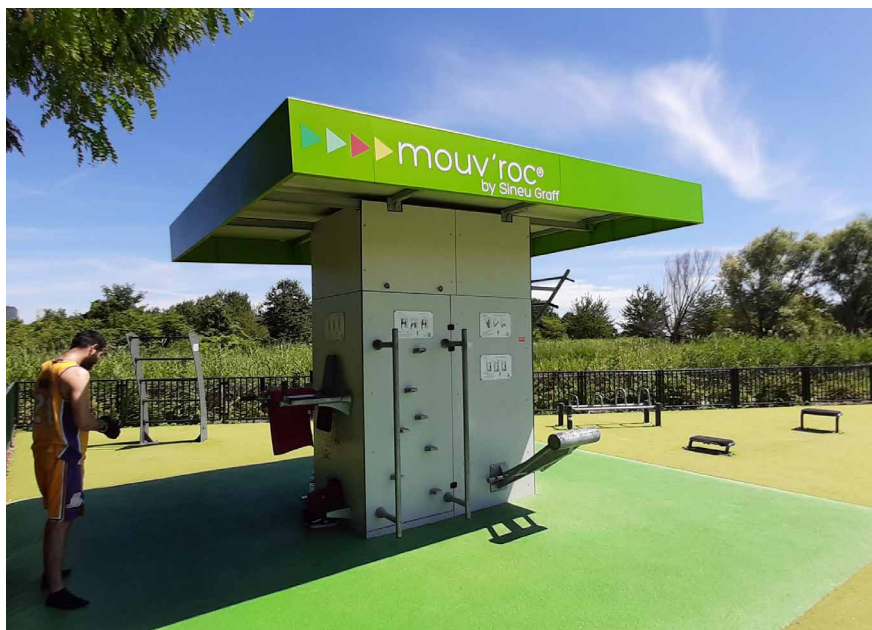

**Mouv'roc® Tigre**  
Montreuil - 93 - France



**Mouv'roc® Lion**  
Reckange-sur-Mess - Luxemburg

**Open Mouv'roc®**  
Lisieux - 14 - France

**Open Mouv'roc® and inclusive arch**  
Bellot - 77 - France





**Set of satellites and Link furniture**  
Paulhan - 34 - France

**Open Mouv'roc®**  
Landevant - 56 - France



**Space'Roc®**



**Space'Roc®**



# Combo satellites

**Design:** Sineu Graff

**Materials:**

Apparatus: Galvanised steel

Surfaces: HDPE

Punching bag: reinforced rubber



**Io**  
4 simultaneous users  
12 exercises  
Ref. 07 200



**Luna**  
4 simultaneous users  
10 exercises  
Ref. 07 220



**Léda**  
4 simultaneous users  
13 exercises  
Ref. 07 210



**Styx**  
4 simultaneous users  
12 exercises  
Ref. 07 240

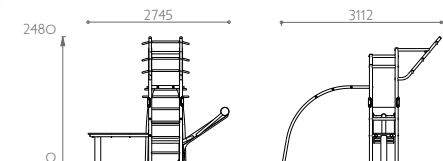
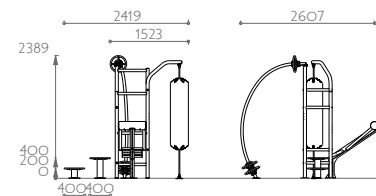
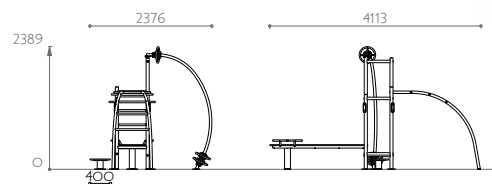
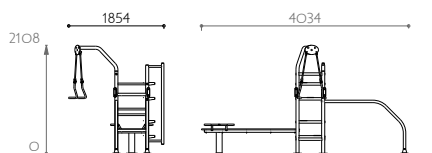

# Combo satellites

**Design:** Sineu Graff

**Materials:**

Apparatus: Galvanised steel

Surfaces: HDPE

Punching bag: reinforced rubber



**Sao**  
4 simultaneous users  
16 exercises  
Ref. 07 230



**Cross-Training Ladder**  
5 simultaneous users  
15 exercises  
Ref. 07 101



**Mimas**  
6 simultaneous users  
14 exercises  
Ref. 07 250



**Gyroscopic Ladder**  
5 simultaneous users  
5 exercises  
Ref. 07 104

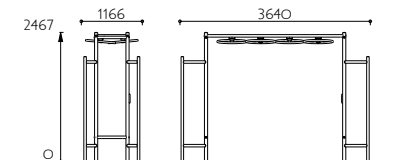
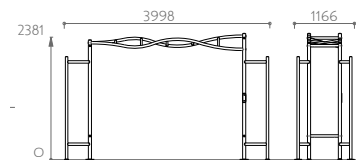
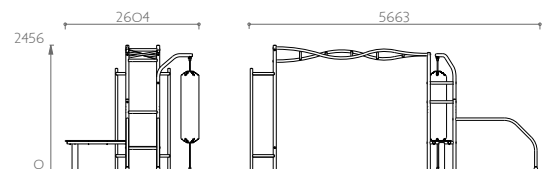
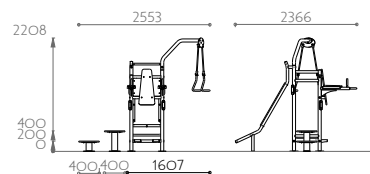

# Solo satellites

**Design:** Sineu Graff

**Materials:**

Apparatus: Galvanised steel

Surfaces: HDPE



**Lumbar roll**  
1 user  
4 exercises  
Ref. 07 105



**Parallel bars**  
2 simultaneous users  
6 exercises  
Ref. 07 102



**Triple parallel bars**  
4 simultaneous users  
7 exercises  
Ref. 07 103



**Low Stepper**  
1 user  
5 exercises  
Ref. 07 106



**Medium-level stepper**  
1 user  
5 exercises  
Ref. 07 107



**Inclusive Arch**  
3 simultaneous users  
6 exercises  
Ref. 07 100

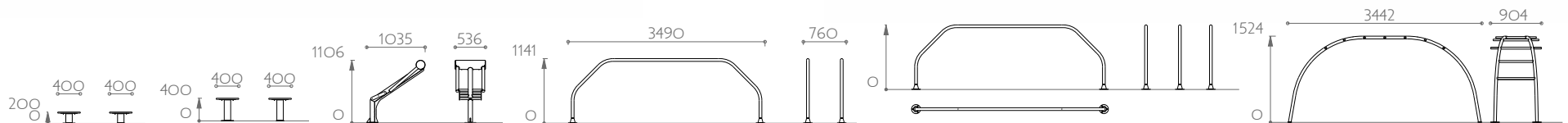

# Senior solo satellites

**Design:** Sineu Graff

**Materials:**

Apparatus: Galvanised steel

Surfaces: HDPE

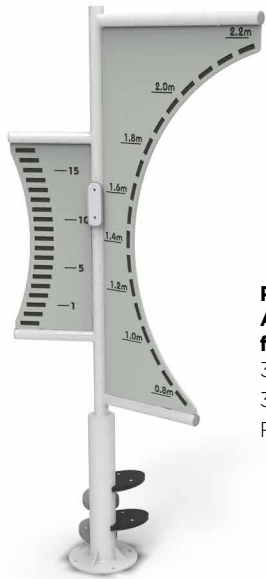

**Rhéa**  
Arms and legs measuring rods,  
fingers dexterity ladder  
3 simultaneous users  
3 exercises  
Ref. 07 113



**Chaotic pathway**  
1 user  
1 exercise  
Ref. 07,108



**Rotating Disc**  
1 user  
2 exercises  
Ref. 07 110



**Double Rotating Disc**  
1 user  
4 exercises  
Ref. 07 111



**Senior seat**  
1 user  
4 exercises  
Ref. 07 109

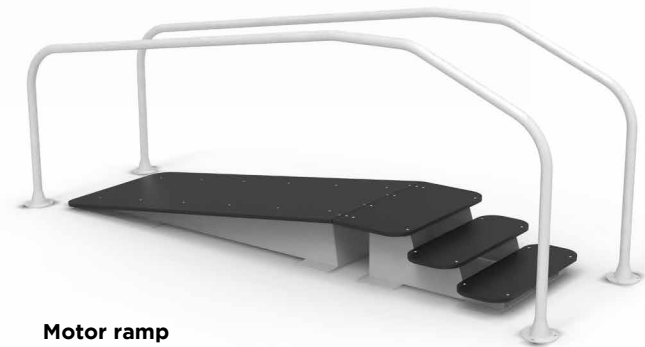

**Motor ramp**  
3 simultaneous users  
6 exercises  
Ref. 07 112

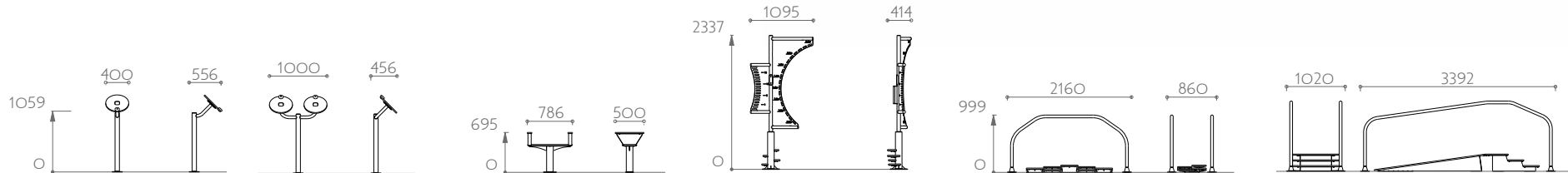







Space'Roc®

# Space'roc®

**Design:** Sineu Graff

**Materials:**

Roof: Zinc and powder coated steel

Panels: HPL

Apparatus: Galvanised steel



**Space'roc® L**  
Ref. 09 312 01  
Shown with Live furniture



**Space'roc® XL**  
Ref. 09 412 01  
Shown with 2 shutters

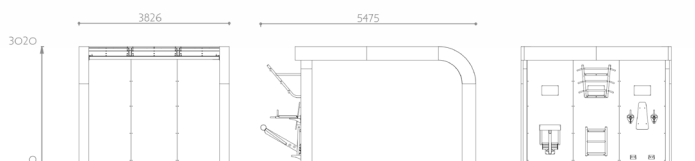

**Space'roc® XL**  
Ref. 09 417 01  
Shown with Arobase furniture

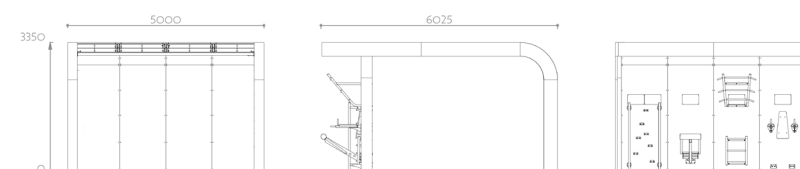

# Ingenious city

## Imagining the city of the future.

To charm and enchant its people, a city must offer street furniture with a subtle aura. Like a visual language, it employs shapes, materials and colours to reflect the harmonious aesthetics of its design. It reveals the unique essence of each neighbourhood, offering personalised facilities to its residents. The graceful alliance of these elements shapes the identity of the city, a soothing aesthetic woven with real sensitivity. The time we spend there reflects its appeal, a useful mirror of its popularity. With the increasing footfall of visitors and users, brought by soft public transport, the city opens up a new landscape, full of vibrant, attractive vitality. And so a virtuous circle takes shape, where everyone finds fulfilment.



*Large spaces*

**sineu  
graff**  
STREET FURNITURE

**Ylozen layout**  
Meaux - 77 - France

[www.sineugraff.com](http://www.sineugraff.com) - 221

**sineu  
graff**

# Grand Large

Design: Yannick & Camille CLAESSENS-VALLET

Grand Large furniture  
Calais - 62 - France

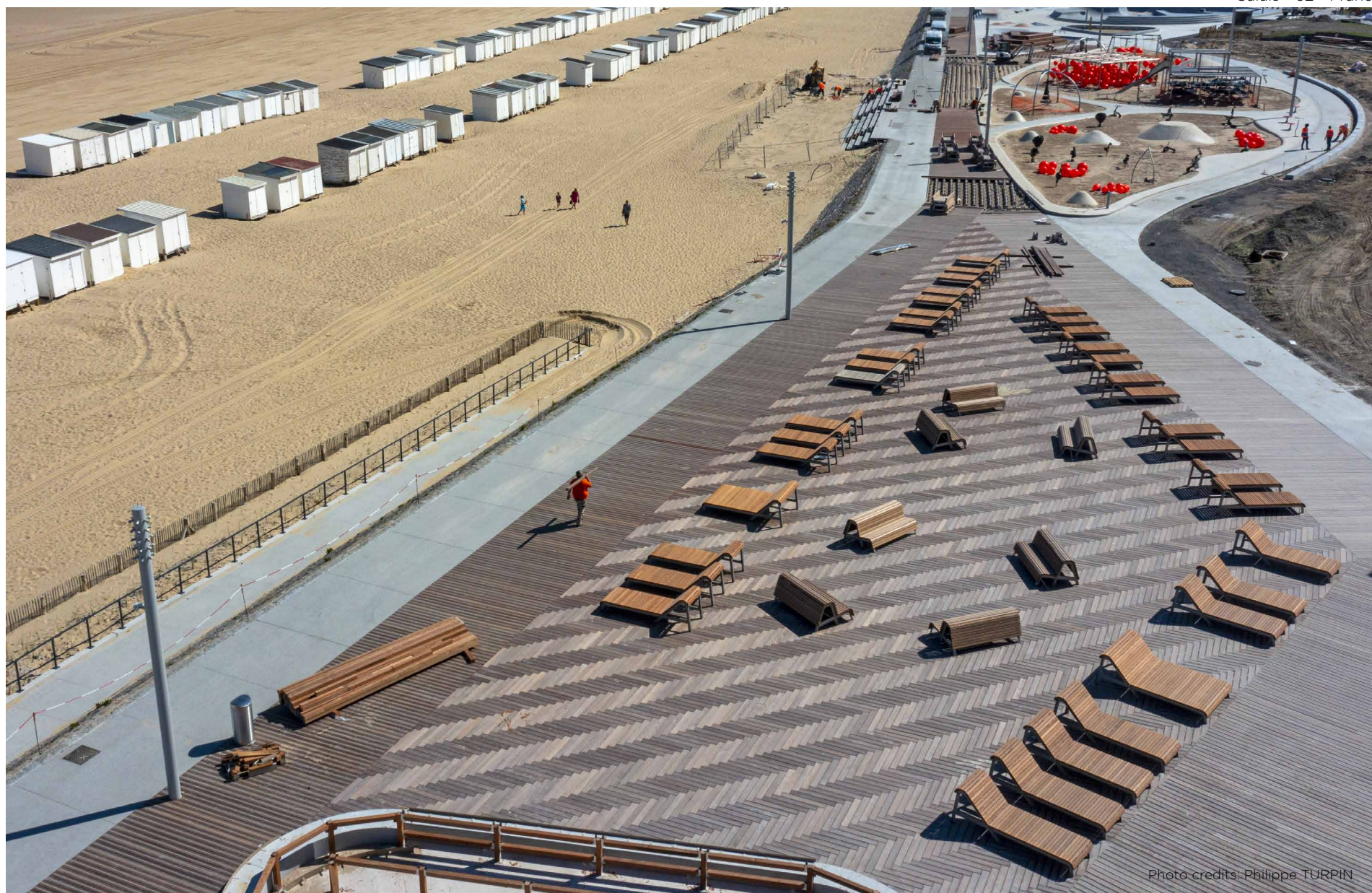

Photo credits: Philippe TURPIN

Photo credits: Philippe TURPIN

# Large spaces



**Grand Large Furniture**  
Calais - 62 - France

[www.sineugraff.com](http://www.sineugraff.com) - 223



*Large spaces*



**Idylle customized seat**

La Teste-de-Buch - 33 - France



**Idylle customized seat**  
La Teste-de-Buch - 33 - France



**Conversation seats**  
Beauvais - 60 - France

*Large spaces*

**sineu  
graff**  
STREET FURNITURE



**Conversation seats**  
Beauvais - 60 - France

[www.sineugraff.com](http://www.sineugraff.com) - 227

**sineu  
graff**

*Private collections*



**Customized Tree grille**  
Bourgoin-Jallieu - 38 - France

**Seats on low walls**  
Antibes - 06 - France



**Birth tree 2020**  
Chatenay-Malabry - 92 - France



**Birth trees 2021**  
Chatenay-Malabry - 92 - France

**Book box with seat**  
Strasbourg - 67 - France



**Customized seat**  
Roppenheim - 67 - France

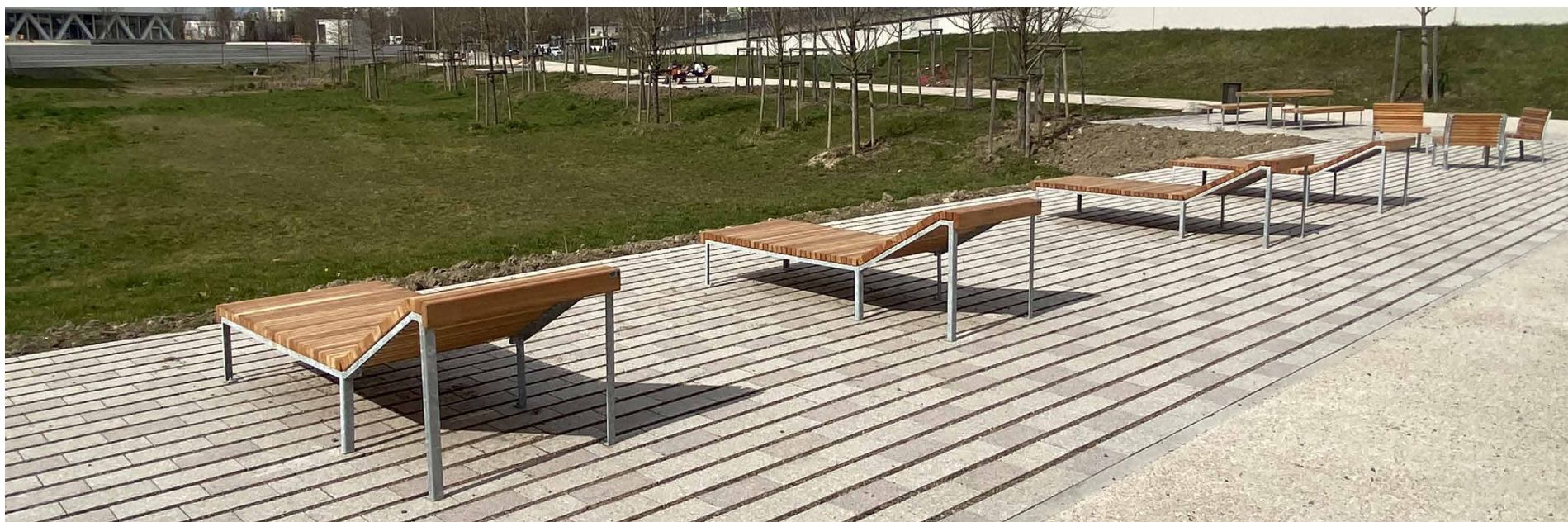

**Customized seats**  
Illkirch-Graffenstaden - 67 - France





**Arches with seats**  
Colmar - 68 - France



**Arches with seats**  
Colmar - 68 - France



**Customized seats**  
Mulhouse - 68 - France

# Private collections

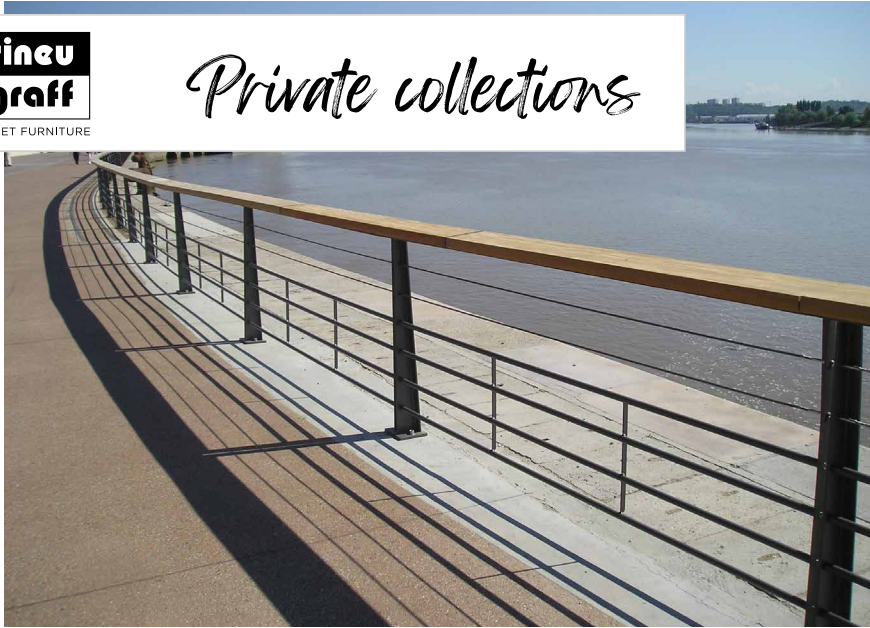

**Customized safety rail**  
Bordeaux - 33 - France



**Seat with personalised laser laser cuttings**  
and integrated shelf - Le Havre - 76 - France

**Customized seating**  
Vaulx-en-Velin - 69 - France

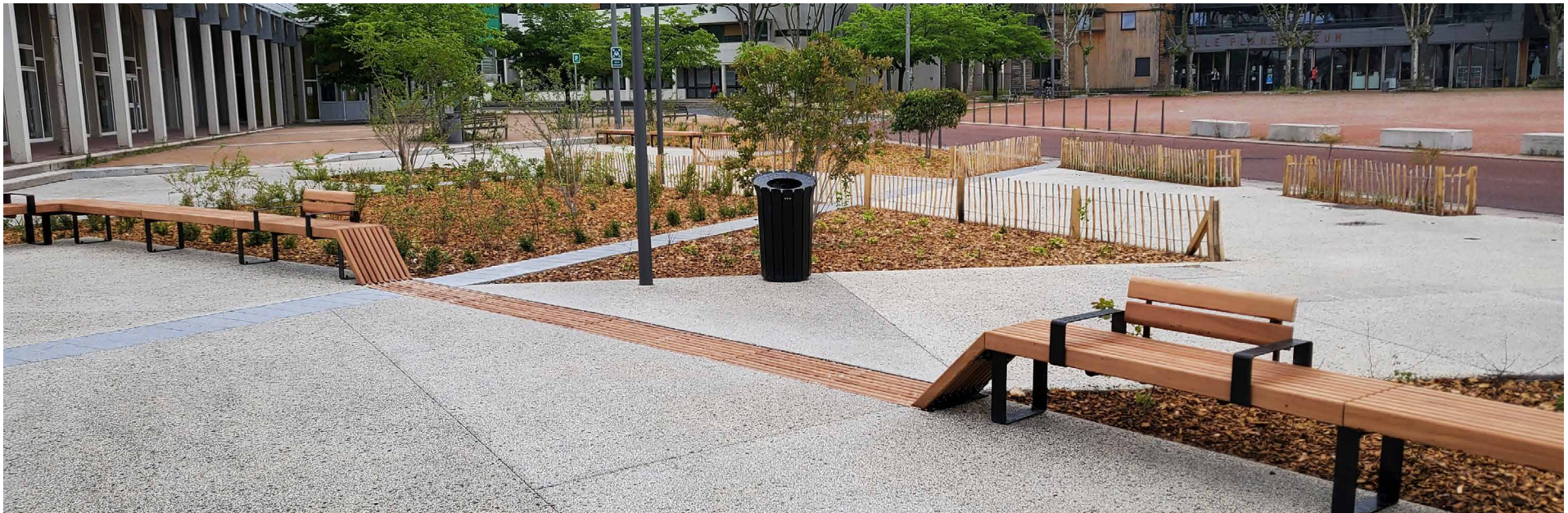



**Smoking shelter**  
Obernai - 67 - France

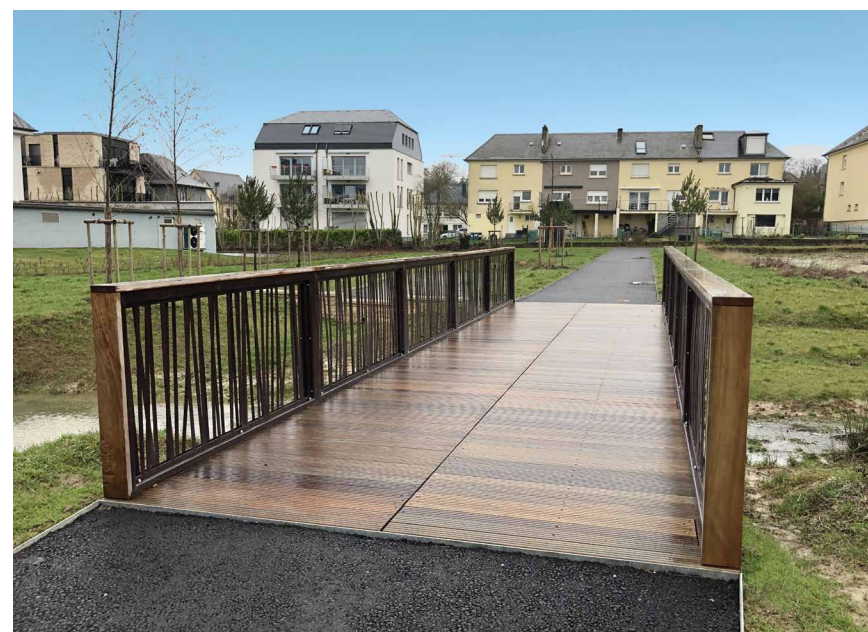

**Customized footbridge**  
Hesperange - Luxemburg

**Corten®-type steel columns**  
Argenteuil - 95 - France

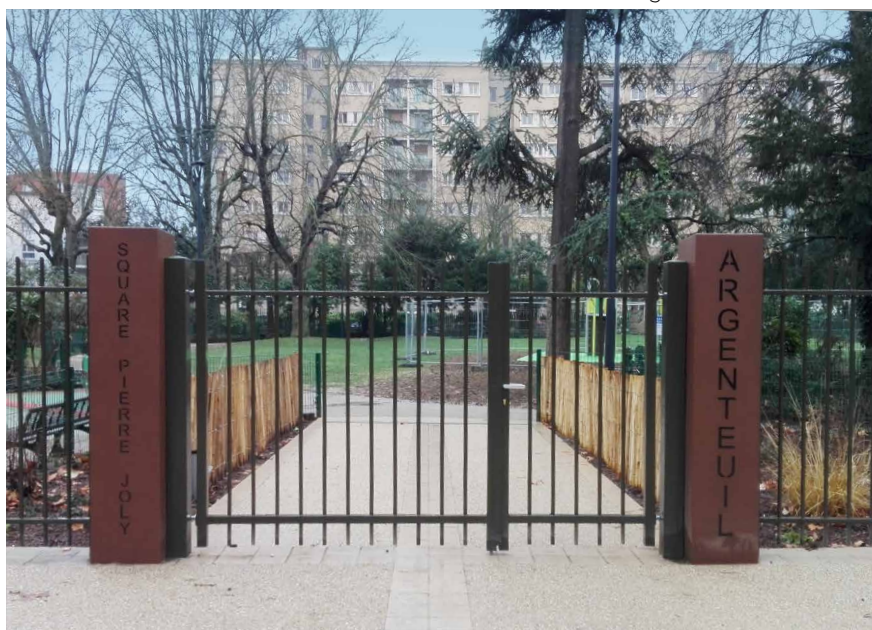

**Plant seats**  
Banyuls-sur-Mer - 66 - France

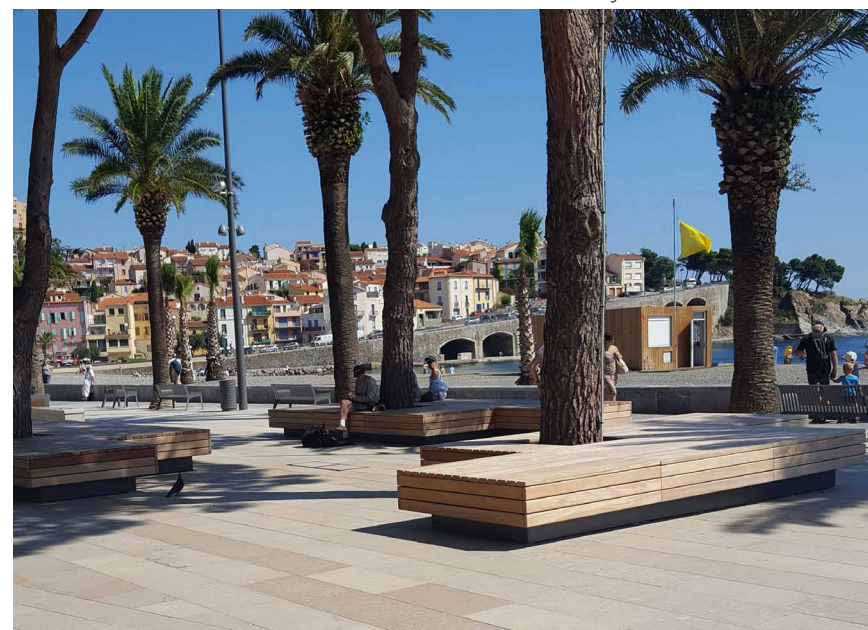



**1 bench with bicycle guard**

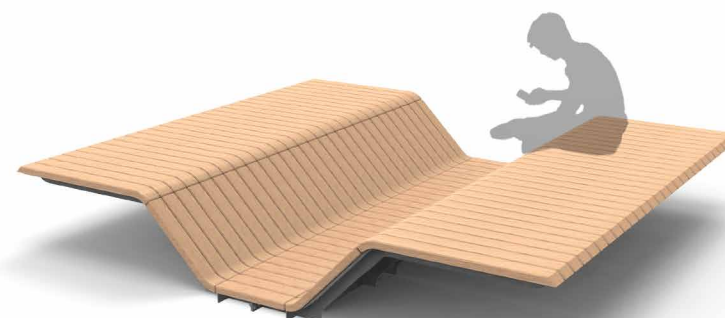

**3 benches side by side**

The 'Freedom Bench' was created by Arch. Cindrella W. Semaan for Red Sea Global, in Saudi Arabia. It is designed as a seat summarizing Red Sea Global's social and sustainable development vision.

The "Freedom Bench" is a piece of durable, eco-friendly furniture, inspired by the flowing shapes of the Red Sea's waves and sand dunes, which intersect in the middle of the seat structure to connect with the roots in the ground, where a tree is added as a source of shade.

The floating wings represent the vision of freedom, pride, security and uniqueness that Red Sea Global seeks to offer every visitor.

# The Freedom Bench

**Design:** Cindrella W. SEMAAN

**Materials:**  
FSC® hardwood  
Stainless steel



**Bench with opening for tree grille**

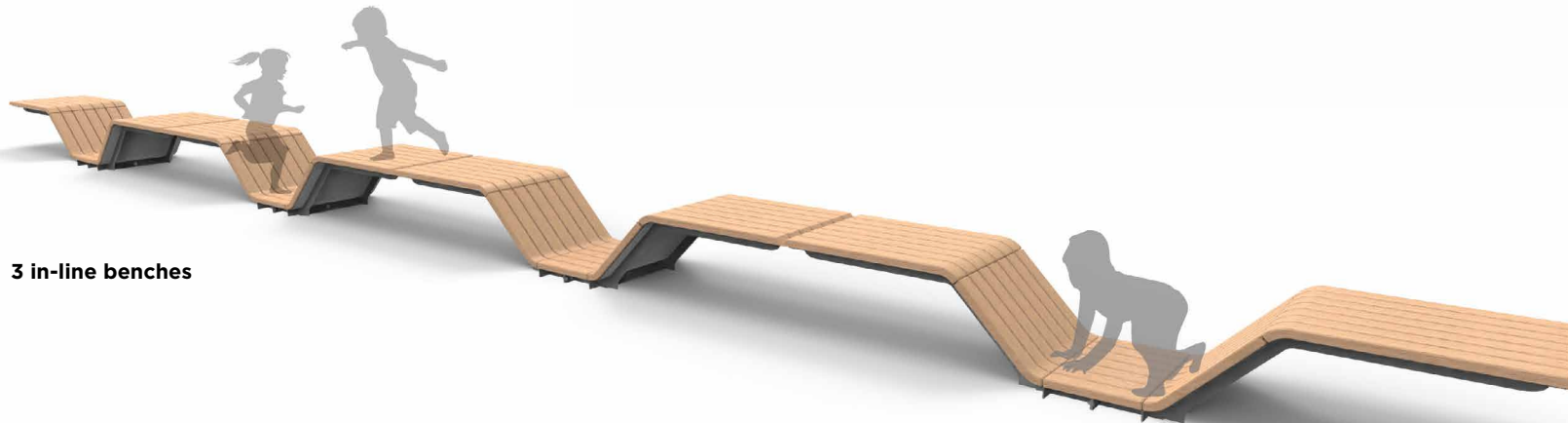

**3 in-line benches**



# Logs seat

**Design:** Sineu Graff

**Materials:**

Unstained oak

Zinc and powder coated steel base

## Logs seat

Ambillou - 37 - France



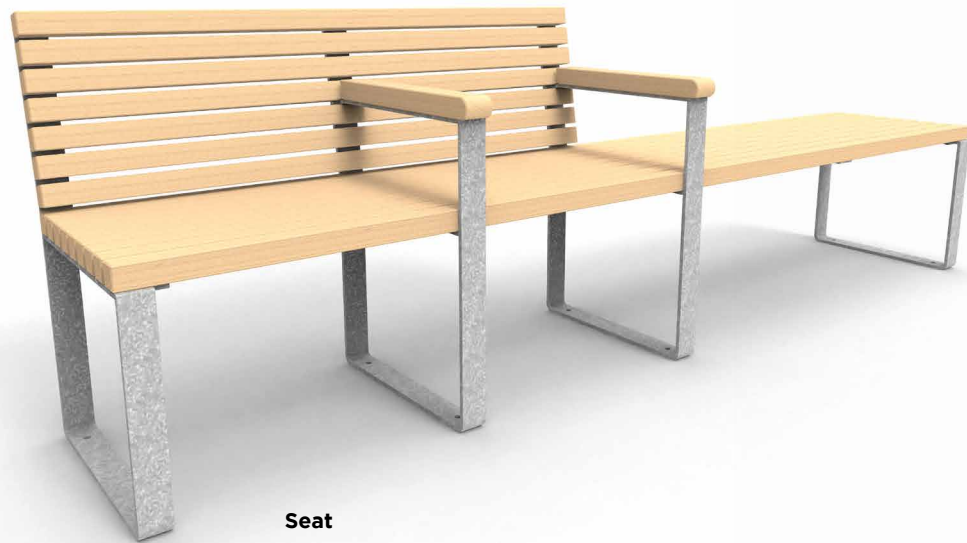

**Seat**

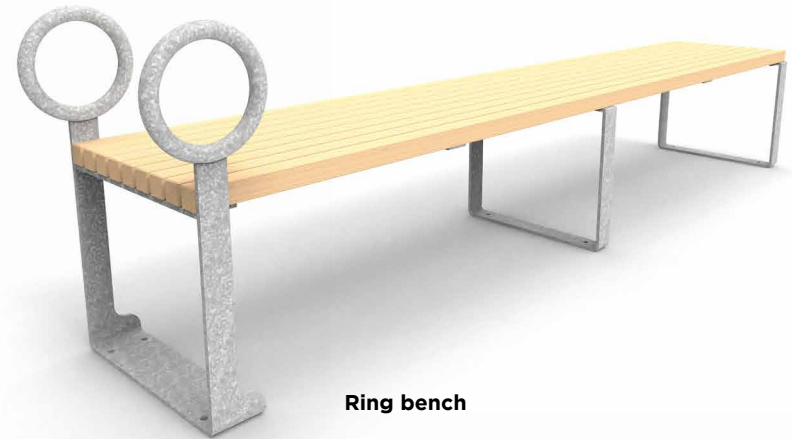

**Ring bench**



**Bench**



**Bench 1 apparatus bar**



**Parallel bars apparatus bench**



**Step apparatus bench**

**Sineu Graff has risen to the challenge of 2024: to offer the greatest athletes in the world an innovative urban landscape, suitable for everyone, integrated, sporty and sustainable that future generations will be able to use.**

For this extraordinary project focused on inclusion without stigmatisation, Sineu Graff has brought three talented experts on board: Clément Willemin (Agence Wald) for design and integration into the landscape, Alexandre Moronnoz for design and use, Philippe Moreau & Ricardo Leone (Tactile Studio) for inclusive and sensory design - openness to all forms of impairment, especially visual impairment. Together, they created "PODIUM", a range of inclusive street furniture, which addresses present and future challenges. The Podium range reflects the image of the Olympics: excellence, difference, skills, games... Who hasn't dreamed of one day stepping onto the PODIUM!

# Podium

**Design:** Clément WILLEMIN - Agence Wald,  
Alexandre MORONNOZ,  
Philippe Moreau & Ricardo Leone - Tactile Studio

**Materials:**  
Unstained larch  
Galvanised steel



**Deckchair armchair**



**Stool**

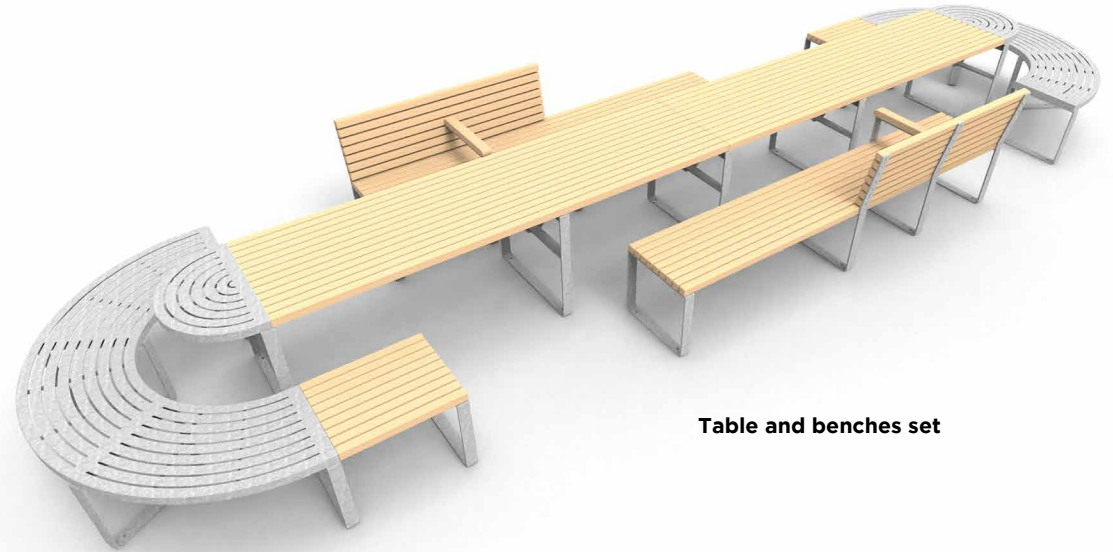

**Table and benches set**



**Sofa**



**Love seat**



**Chair**

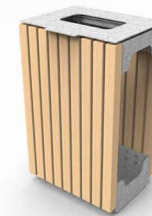

**Litter bin**



**Bicycle stand**

# About Sineu Graff

## Producer of street furniture for over 50 years



A major partner of project owners and designers, Sineu Graff offers professionals in the landscaping of public space a complete range to meet the needs of users and build the city of tomorrow.

**Sineu Graff designs products and solutions** with its design and innovation department, **manufacturing them entirely in its** historic workshops, in Kogenheim in Alsace, equipped with the most innovative processes and technologies, carrying out the paint treatment itself, and offering them to the market through its integrated commercial network as close as possible to its Customizeders.

This organisation is supplemented by **an international network of more than 30 distributors.**



## Commitment to sustainable development

Sineu Graff, through a new production methodology, reflects and invests in industrial and technical processes that use the most advanced technologies to combine economic and environmental performance.

An eco-design approach is systematically applied to product development. They are designed from **100% recyclable materials** whose use is optimised (management of offcuts, maintainability, etc.), such as wood, steel, stainless steel, aluminium, recycled high-density polyethylene and cast aluminium. They are **all recyclable at the end of their life.**



Our industrial production tooling has been the subject of constant investment, guaranteeing the **implementation on our production site of processes that have the least impact on the environment** by eliminating organic solvents in wood finishing treatments, and the introduction of technical solutions that save energy and resources.

Sineu Graff also offers a **specific range of furniture to promote reuse and/or committed to biodiversity**, such as the Refuge® seat for insects, the Mote urban composter, the Reliefs litter bin and Greffon seating furniture.

Finally, we offer **spare parts** for the maintenance of our furniture, as well as a repair programme, on site or in the workshop, to **extend the life cycle of furniture** and ensure its reuse.

## Designers

This industrial and environmental design can only be achieved thanks to a collaboration of trust with numerous designers, all driving forces behind the Sineu Graff philosophy of quality, originality, ergonomics and use.

With them, many pieces of furniture have been created:

**Bernard ALTHABEGOÏTY:** Conversation, Conversation Tablette, Azur Tab'

**Charles BOVÉ:** Contemporary litter bin

**Emmanuel CAIRO:** Diapason

**Coline CHABIRON:** Bobine

**Gwendoline DOS SANTOS:** Greffon

**Yannick & Camille CLAESSENS-VALLET:** Grand Large

**Julien HOFFMANN & Philippe RIEHLING -**

**Défi Écologique:** Refuge Bench®

**Arturo ERBSMAN:** Idylle, Pétales, Eidos

**Michael HENNEMANN:** Nine

**Vincent MAYOT - Agence Mayot et Toussaint:** Volubilis

**ALEXANDRE MORONNOZ:** Arobase, Podium,

**Aliénor MORVAN:** Mote

**Cécile PLANCHAIS:** Garden City, Optima, Opticar, Jardins Mobiles, Tango

**Philippe RIEHLING:** Link, Azur, Reliefs

**Emmanuel ROULET:** Rendez-Vous, Zenith, Metropolis

**Fred TERRY - Agence STOA:** Twist, Live

**Clément WILLEMIN:** Rubber Line

## Our low-carbon strategy through our “ACT Step by Step” approach



In response to the carbon assessment carried out in 2019, **Sineu Graff adopted an energy sobriety plan as well as an ambitious policy in terms of SER** (Social and Environmental Responsibility).

The main objective of this plan, in correlation with the Paris agreements and the plan led by ADÈME, is to reduce our CO<sub>2</sub> emissions by 20% by 2035.

For this, after the installation in 2020 of a biomass boiler using wood scraps and dust from our carpentry manufacturing to supply the offices and workshops with heating, as well as our stain drying oven, we have determined a plan of action based around 5 pillars:

- Redefinition and prioritisation of suppliers committed to a low-carbon policy
- Transparent institutional communication on our low-carbon policy
- Commitment to a circular economy and creation of an offer to extend the life of furniture
- Development and design of virtuous products systematically integrating the carbon impact
- Raising employee awareness of low-carbon culture, all becoming project leaders

The deployment of this low-carbon transition strategy is carried out with the company Alternative Carbone according to ADÈME’s “Act Step by Step” system.

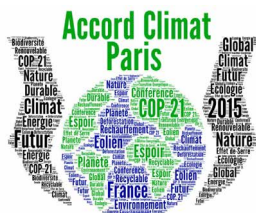

## Our certifications

### 4 patents

**City Confort®** - seating furniture range: system for assembling round bars on spacers.

**Jumbo®** - litter bin range: revolutionary method of collecting urban waste.

**Easy Grip®** - litter bin range: Unique patented bag grip system | European patent

**Sineu Flor®** - street planting range: optimising revegetation by saving water and associated resources.

### 500 model deposits

Sineu Graff owns more than 500 models (registered with the National Institute of Intellectual Property), divided into 5 product families: seating furniture, cleanliness, street planting, protection and safety, sport and health.

### Sineu Graff is FSC® and PEFC certified™

Our company is **FSC®**-certified and subject to the FSC® (CDC) chain of custody, which guarantees traceability in the route taken by products from FSC®-certified forests, or, in the case of recycled materials, from the recovery of materials to the point of sale.

In addition, for local wood, Sineu Graff is labelled **PEFC™**.



JANUS 2023 DE LA CITÉ

Sineu Graff received the Label of Excellence

**Janus de la Cité 2023**

from the French Institute of Design.

## Networks and partnerships

Active member of the **Street Furniture Group of French Furniture.**



### Partner of urban landscaping professionals:

**FFP:** French Landscape Federation,

**HORTIS:** Managers of Nature Spaces in the City,

**AITF:** Association of Territorial Engineers of France,

**ATTF:** Association of Territorial Engineers of France,

**ANDIISS:** National Association of Directors and Operators of Sports Facilities and Services,

**CNVVF:** National Council of Flower Towns and Villages,

**ARF CENTRE VAL DE LOIRE:** Regional Association for the Street Planting and Enhancement of Municipalities in the Centre-Val de Loire region.

**Member of Sustainable Initiatives, initiatives in sustainable development,** reference network in the Grand Est committed to economic, societal and environmental responsibility.



**Member of ImaginAlsace:** the Alsace shared brand is a “flagship” that symbolises the region, its identity, its values, as well as its objectives and future. It belongs to all the stakeholders who promote the influence of the region.



# Our materials

Sineu Graff furniture is intended for outdoor use: it must withstand all types of weather conditions and intensive collective use. To do this, it carefully selects wood species and types of steel, and applies special treatments if necessary for optimal protection and resistance over time.

## Wood

A warm and natural material, wood imbues our furniture with Confort, a pleasant feel, and a polished appearance. Available in different species, our furniture is made from wood harvested exclusively from natural forests. The premier choice, they come from sustainably managed forests and are labelled FSC® (hardwood) or PEFC® (local woods).



All our furniture is available in FSC® wood on request.

For its furniture, Sineu Graff has chosen to use different types of wood: ash and larch of French or European origin, and hardwood from West African forests.

In their natural version, hardwood and larch do not require any surface treatment thanks to their resistance and natural rot-proofing if they remain out of contact with the ground.

Hardwood can also be stained and painted for aesthetic purposes.

As for ash, it must receive a surface treatment to protect it against fungi and parasitic insects: autoclave treatment if the wood remains in its natural version, treatment by application of stain if the wood is painted.

The wood stain treatment is carried out on our automatic lacquering line in our factory in Alsace.

### The colours proposed:

Sineu Graff proposes a wide choice of colours for wooden parts. Standard options are: natural or light oak, walnut, mahogany, and certain opaque wood stain colours, as per the colour chart. On request, other colours in the ral colour chart can be applied to wooden parts.

## Steel

A material used for its solidity, its pliability, and its capacities for transformation (folding, bending, cutting, rolling) and for assembling (welding, bolting), steel guarantees furniture the highest degree of solidity.

Materials are obtained from suppliers specialising in the production or marketing of stainless or special steels. The steel used in our workshops is of S235 quality, standard NF EN 10027, or S235, depending on the type of furniture. All stages of processing our steel sheets and profiles are carried out in our workshops.

Following manufacturing of furniture in crude steel, the steel parts are then treated either by galvanisation or by electrolytic galvanising to ensure optimum rust protection and sustainable performance.

### Zinc and powder coated steel

The furniture is treated by powder coating according to our Powder Blast process, carried out on our site in Alsace.



### POWDER BLAST: the Sineu Graff paint guarantee

A series of four operations in a continuous process ranging from preparation of parts to their painting and consisting in:

- Alkaline degreasing, followed by rinsing and meticulous drying, in order to wash and degrease the parts
- Shot blasting of the parts in order to treat the fillet welds and make the part surfaces homogeneous and rough to ensure good mechanical adhesion of the powder paint
- Application of an epoxy powder anti-corrosion primer, zinc-enriched, polymerised by gelification at 120° (thickness 60 Qm)
- Application of a polyester finishing powder after cooling, giving the chosen colour, polymerised by oven treatment at 180° for 40 min (thickness 60 to 80 Qm).

Application of powders (primer and finishing) takes place by electrostatic process to ensure homogeneous and continuous distribution of powder on the part.

### Galvanised steel

Galvanising protects steel from corrosion, thus guaranteeing it a remarkable life span, while offering a neutral visual aspect that bestows on steel all its nobility. This treatment consists in covering a part with a zinc coat (thickness 60 Qm) by immersion in a molten zinc bath at 450°C.

We use this treatment on certain ranges for steel parts intended to remain in their untreated state, such as the galvanised steel link structure or other components that don't need to be painted.

# Our warranties

The Sineu Graff furniture and spare parts benefit from warranties that vary according to the models and under the following conditions:

- 10 years** **Wooden parts**  
 Parts are guaranteed against decay under normal conditions of use (excluding splits, cracks, vandalism, impacts). The warranty concluded depends on the wood species.
- 2 years** **Stain treatment**  
 This treatment is guaranteed in normal conditions of use (excluding vandalism, impacts).
- 10 years** **Metal and cast iron parts**  
 These parts are guaranteed against perforating rust in normal conditions of use (excluding vandalism, impacts).
- 5 years** **Powder Blast paint treatment**  
 This treatment is guaranteed in normal conditions of use (excluding vandalism, impacts).
- 10 years** **Galvanising of metal parts**  
 These parts are guaranteed against perforating rust in normal conditions of use (excluding vandalism, impacts).
- 10 years** **HPL (high pressure laminate)**  
 This treatment is guaranteed in normal conditions of use (excluding vandalism, impacts).
- 5 years** **Reinforced Recycled Plastic Parts**  
 RRP parts (reinforced by metal insert) are guaranteed against perforating rust under normal conditions of use (excluding vandalism, impacts, etc.).
- 10 years** **Spare parts**  
 We guarantee the supply of spare parts if a product is no longer manufactured.

## Cast iron

Sineu Graff uses lamellar graphite (LG)-quality cast iron for the legs of the seats or spheroidal graphite quality (SG) for the pebble pot, for example.

Cast iron remains the ultimate durable material, with a lifespan of up to hundreds of years. It offers the most varied possibilities of shapes, as well as a material effect provided by its texture.

Cast iron is painted using our Powder Blast process for better corrosion resistance, ensuring that Sineu Graff furniture has a very high aesthetic quality.

## Reinforced Recycled Plastic

Sineu Graff offers a selection of urban furniture with seats made of recycled reinforced plastic. This material is the ideal solution for spaces with a lot of traffic and that do not require any particular maintenance.

The raw material of recycled reinforced plastic is entirely made of a recycled plastic material (HDPE, LDPE and PP), originating from Western European countries. The mass-dyed boards are made by an extrusion process and are available in 5 colours (Sand, grey, black, green, brown).

## HPL laminated panels

Sineu Graff uses laminated panels, based on high pressure duromers (HPL, High Pressure Laminate) manufactured in laminating presses at high pressure and high temperature. Twice-hardened acrylic polyurethane resins guarantee them outstanding protection against the elements and UVs.

Panels are resistant to scratches, impacts, and solvents, and offer outstanding dimensional stability. This material is very easy to clean.

## Stainless steel

Stainless steel exhibits outstanding corrosion-resistance and does not rust-up, thus making it highly durable. Stainless steel is also used for its aesthetic appearance.

Sineu Graff has chosen grade 316L, called the food grade, over grade 304, in order to ensure optimum durability of its furniture even in harsh environments (saline, wet, etc.). Molybdenum, a component present in stainless steel grade 316, exhibits better corrosion protection in difficult environments.

## Corten®-type weathering steel

Street furniture made of weathering steel, often called Corten® steel, brings a modern yet natural look to the landscape and is appreciated for its resistance and longevity.



Corten® steel is made up of different alloys such as copper (Cu), chromium (Cr), nickel molybdenum (Ni Mo) and phosphorus (P).

This combination increases corrosion resistance by the formation of a self-protective coat known as “patina” with the properties of an S355 grade steel. Normally obtained thanks to transformation factors such as climatic factors (rain, wind, temperature variations, etc.), based on untreated steel, the patina can be obtained by accelerated processes.

Sineu Graff offers different treatments:

- untreated Corten® steel
- rusted Corten® steel
- rusted, varnished and baked Corten® steel.

# Website

The product which is the best suited to your needs from the extensive ranges of options, equipment and Patterns can be yours in just a few clicks. The skill of the design lies in the fact that it gets straight to the point.

**and configure your street furniture in just a few clicks!**

**At any time, you can ask for help with your approach...**

**Click!**

DEVIS / CONTACT

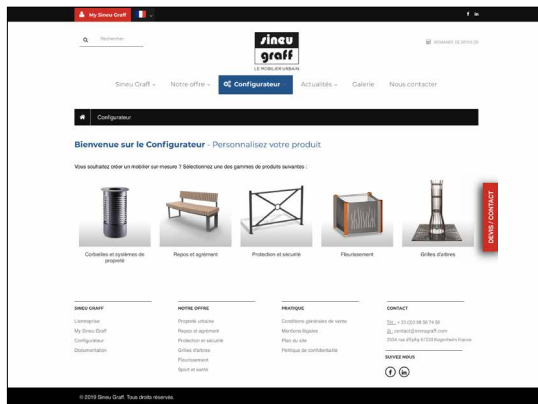

## ▶ Select the product category

Discover all groups of street furniture which, when combined, make the city more human, more lively and more natural.

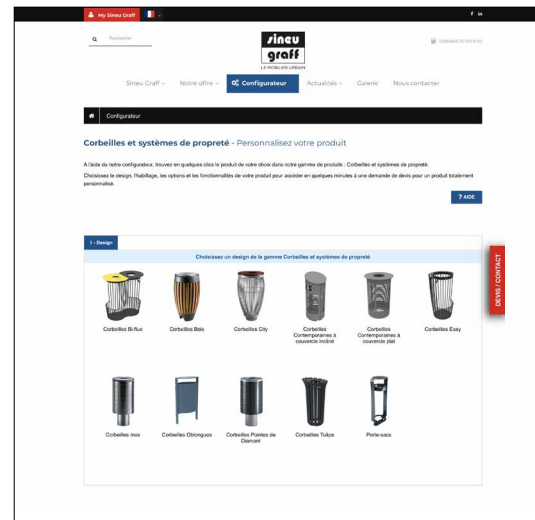

## ▶ Select the design and the range

You will find the same wide range of designs and styles everywhere. Every district of a city has its own personality and, like every company, its own brand image. Configure yours!

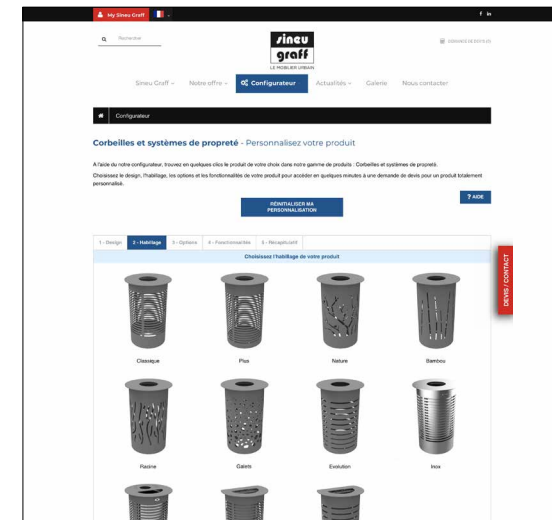

## ▶ Select the patterns

The casing is the first impression we have of furniture which is meant to be discreet whilst knowing how to stand out.

# Configurator

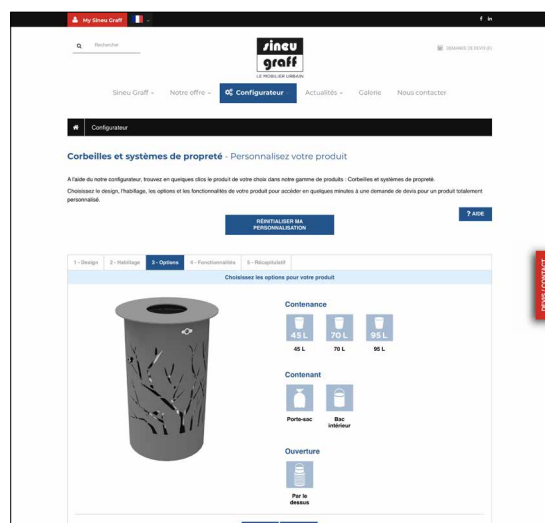

## ► Select the options

A seat with armrests. A waste bin which opens from the top? A tree grille with a reinforced frame. These are the details which reflect the know-how.

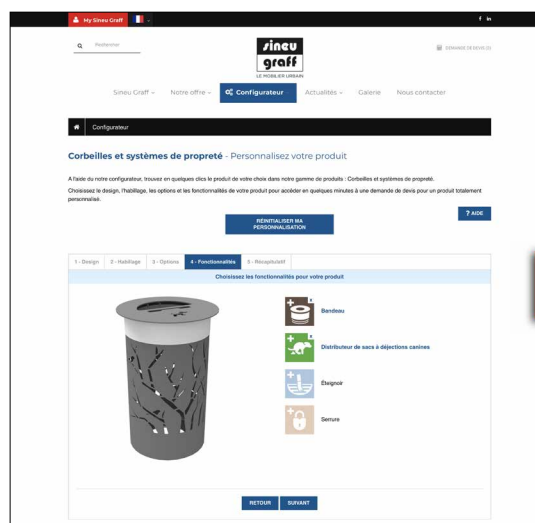

## ► Choose your accessories

You will be surprised to note that we have thought of everything. Accessories such as the cigarette snuffer for waste bins have been invented by observing daily life.

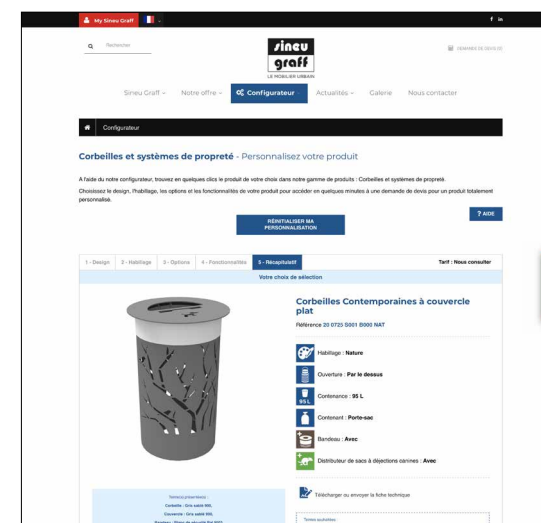

## ► Get a quote and place an order

All your furniture items have been reviewed and carefully selected. The prices will be calculated as accurately as possible.



STREET FURNITURE



The mark of responsible forestry







STREET FURNITURE



[www.sineugraff.com](http://www.sineugraff.com)

INVENTED AND PRODUCED IN FRANCE

